



US008499037B2

(12) **United States Patent**
Ramnani

(10) **Patent No.:** **US 8,499,037 B2**
(45) **Date of Patent:** **Jul. 30, 2013**

(54) **AUTOMATIC PROFILE UPDATE IN A MOBILE DEVICE**

(76) Inventor: **Manoj Ramnani**, Vienna, VA (US)

(*) Notice: Subject to any disclaimer, the term of this patent is extended or adjusted under 35 U.S.C. 154(b) by 268 days.

(21) Appl. No.: **12/737,410**

(22) PCT Filed: **Jul. 15, 2009**

(86) PCT No.: **PCT/US2009/004088**

§ 371 (c)(1),
(2), (4) Date: **Jan. 11, 2011**

(87) PCT Pub. No.: **WO2010/008542**

PCT Pub. Date: **Jan. 21, 2010**

(65) **Prior Publication Data**

US 2011/0113084 A1 May 12, 2011

(51) **Int. Cl.**
G06F 15/16 (2006.01)

(52) **U.S. Cl.**
USPC **709/204**

(58) **Field of Classification Search**
USPC 709/204–207, 217–219; 705/14.49–14.61,
705/14.66–14.69

See application file for complete search history.

(56) **References Cited**

U.S. PATENT DOCUMENTS

6,119,098	A *	9/2000	Guyot et al.	705/14.61
6,601,111	B1 *	7/2003	Peacock et al.	719/310
7,231,204	B1 *	6/2007	Osborn et al.	455/412.1
8,005,904	B2 *	8/2011	Yokoyama et al.	709/206
8,108,240	B2 *	1/2012	Gropper	705/7.18

8,156,330	B2 *	4/2012	Yu et al.	713/168
2001/0020239	A1 *	9/2001	Ukigawa et al.	707/104.1
2003/0069746	A1 *	4/2003	Kuramatsu	705/1
2004/0049538	A1 *	3/2004	Akamatsu et al.	709/203
2004/0253969	A1 *	12/2004	Nguyen et al.	455/515
2005/0034082	A1 *	2/2005	Kim	715/828
2005/0228754	A1 *	10/2005	Pezzaniti et al.	705/64
2005/0265503	A1 *	12/2005	Rotheart et al.	375/354
2006/0074769	A1 *	4/2006	Looney et al.	705/26
2008/0233957	A1 *	9/2008	Akama	455/435.1
2009/0100136	A1 *	4/2009	Jarenskog et al.	709/204
2009/0164589	A1 *	6/2009	Shroff et al.	709/206
2009/0217199	A1 *	8/2009	Hara et al.	715/808
2010/0046486	A1 *	2/2010	Maruyama	370/338
2010/0285786	A1 *	11/2010	Yamada et al.	455/418

FOREIGN PATENT DOCUMENTS

KR 10-2004-0108189 A * 12/2004

* cited by examiner

Primary Examiner — Brendan Higa

(74) *Attorney, Agent, or Firm* — Attentive Law Group, PLLC; Paul Ratcliffe

(57) **ABSTRACT**

A method and system for managing mobile exchange of profile information between a requestor and a recipient. A mobile client is provided on a requestor's first mobile device. The requestor provides requestor profile to an information exchange server through the mobile client. The requestor requests for a connection with the recipient using the mobile client. The mobile client is provided on a recipient's second mobile device. The recipient provides recipient profile to the information exchange server through the mobile client. On acceptance of the request for connection by the recipient, the information exchange server transfers the recipient profile to the mobile client on the requestor's first mobile device and vice versa. The mobile client automatically updates the transferred recipient profile on the requestor's first mobile device based on changes made by the recipient to the recipient profile and vice versa.

19 Claims, 20 Drawing Sheets

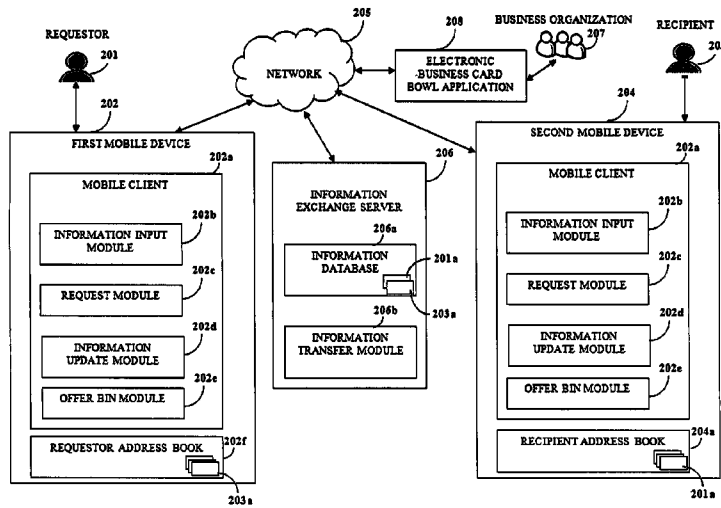

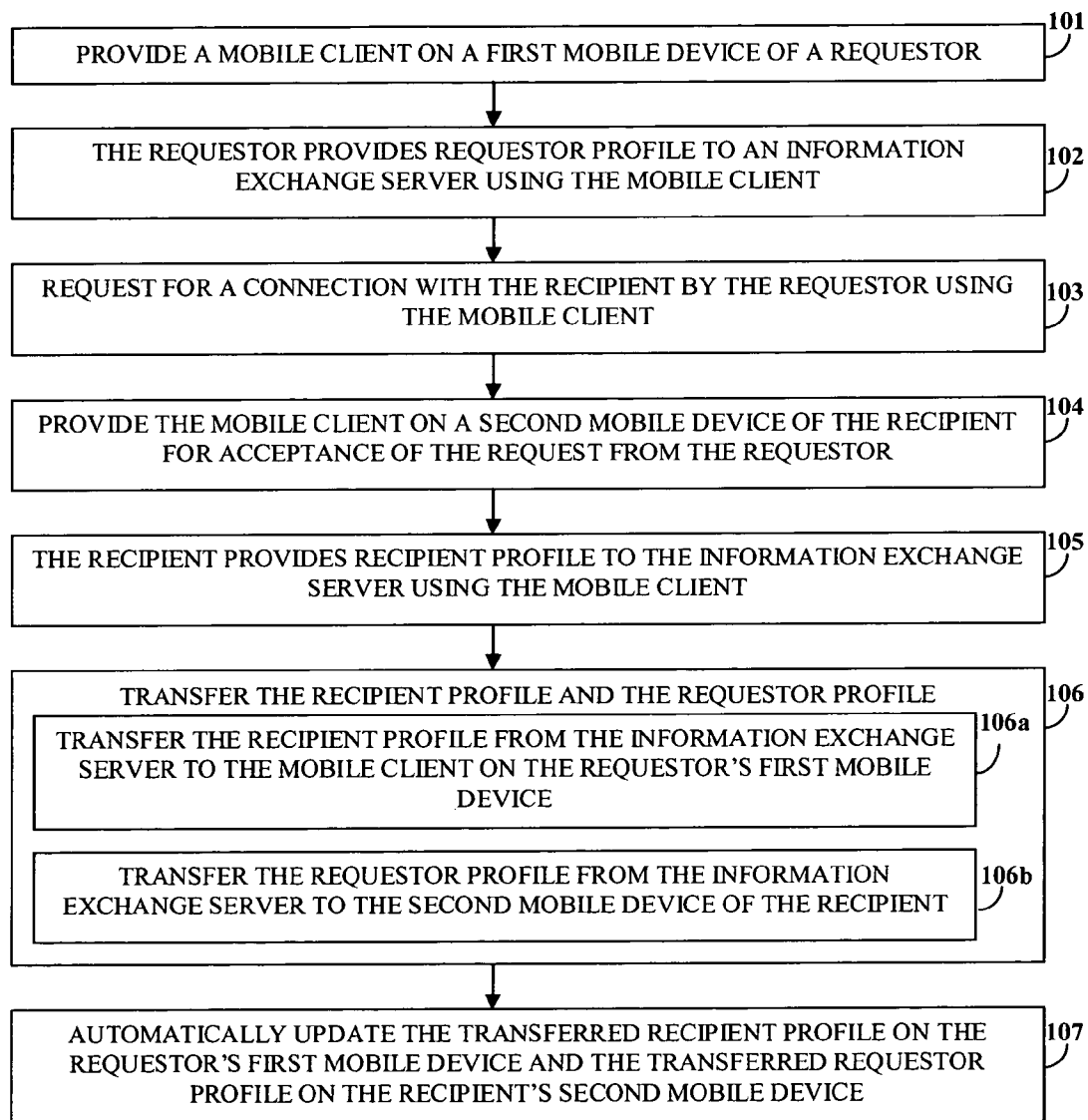

FIG. 1

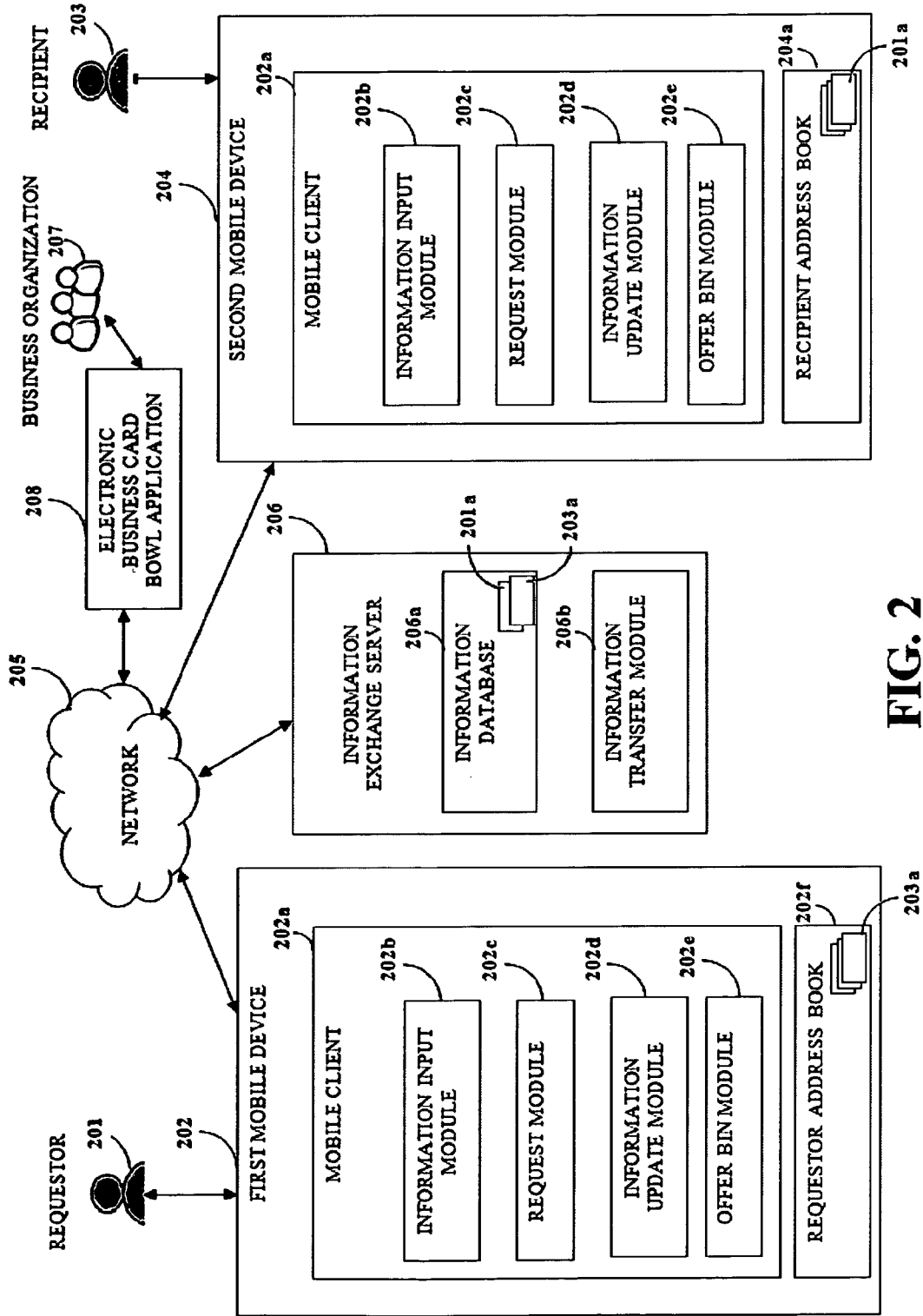

FIG. 2

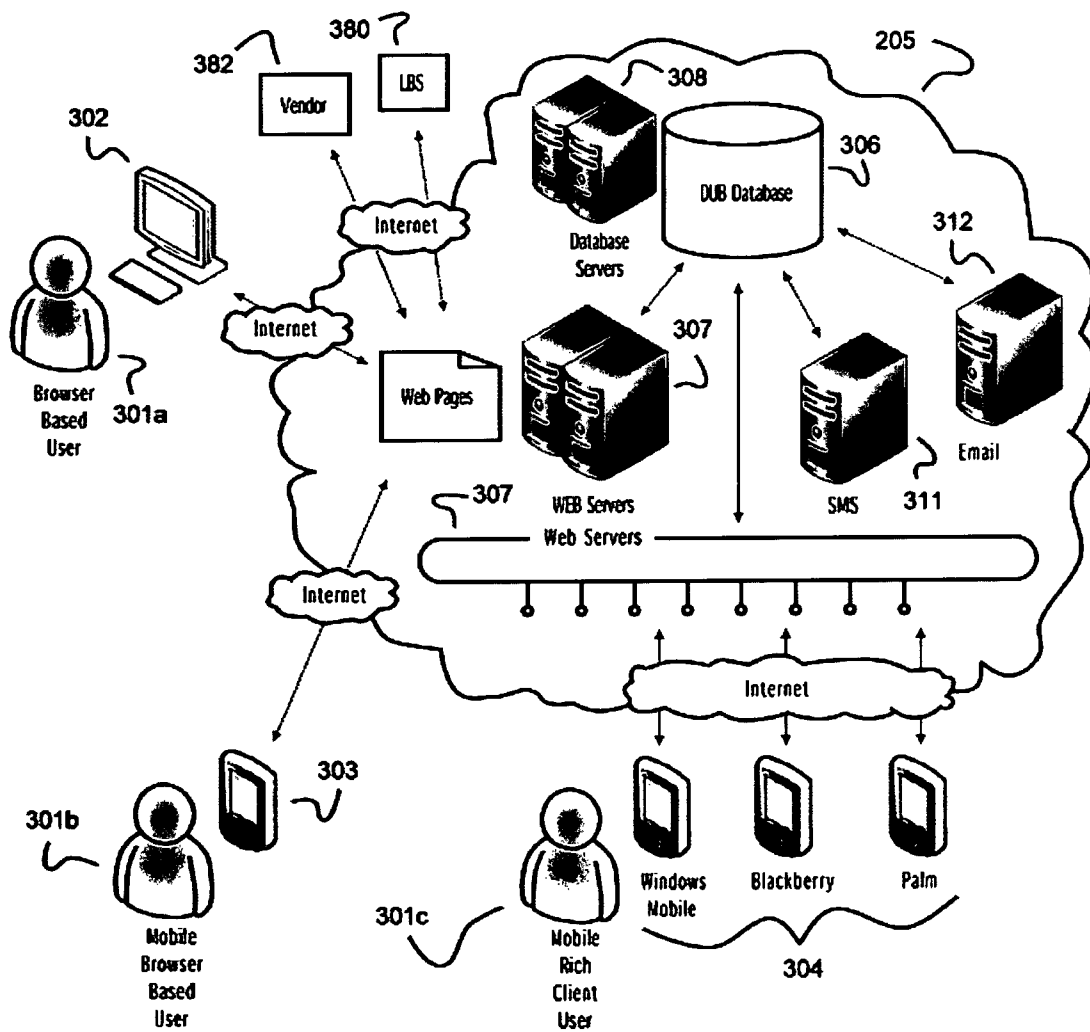

FIG. 3A

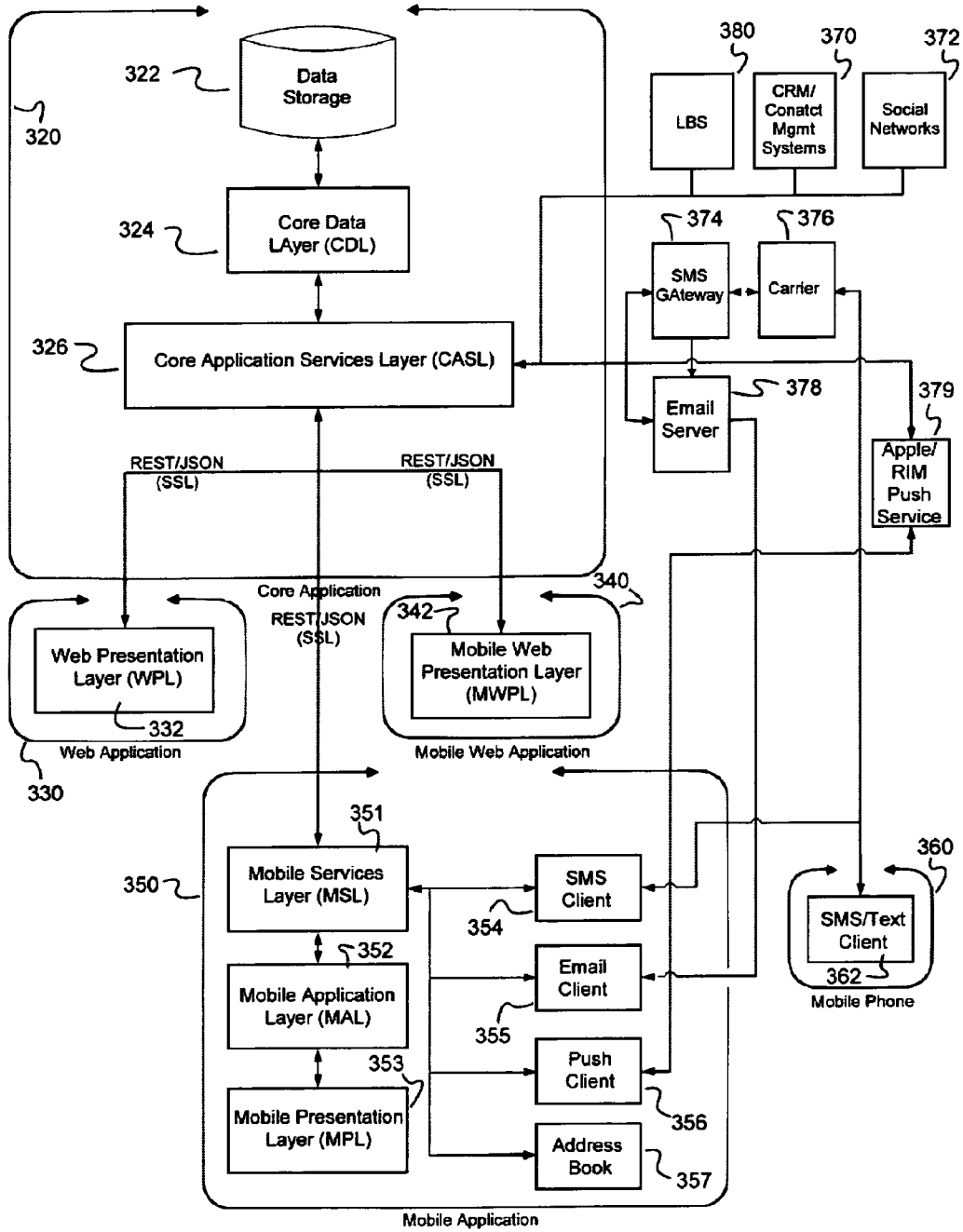

FIG. 3B

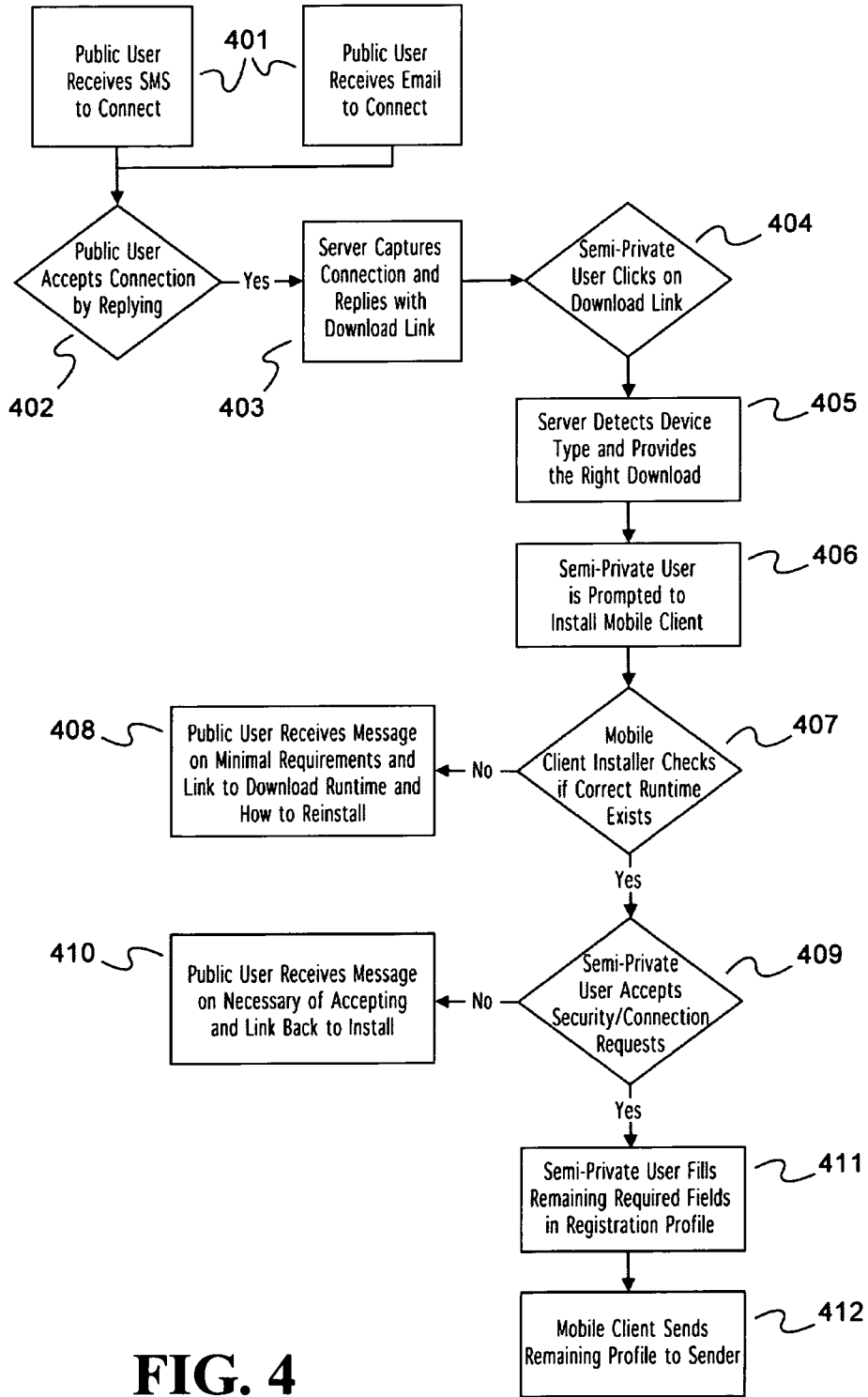

FIG. 4

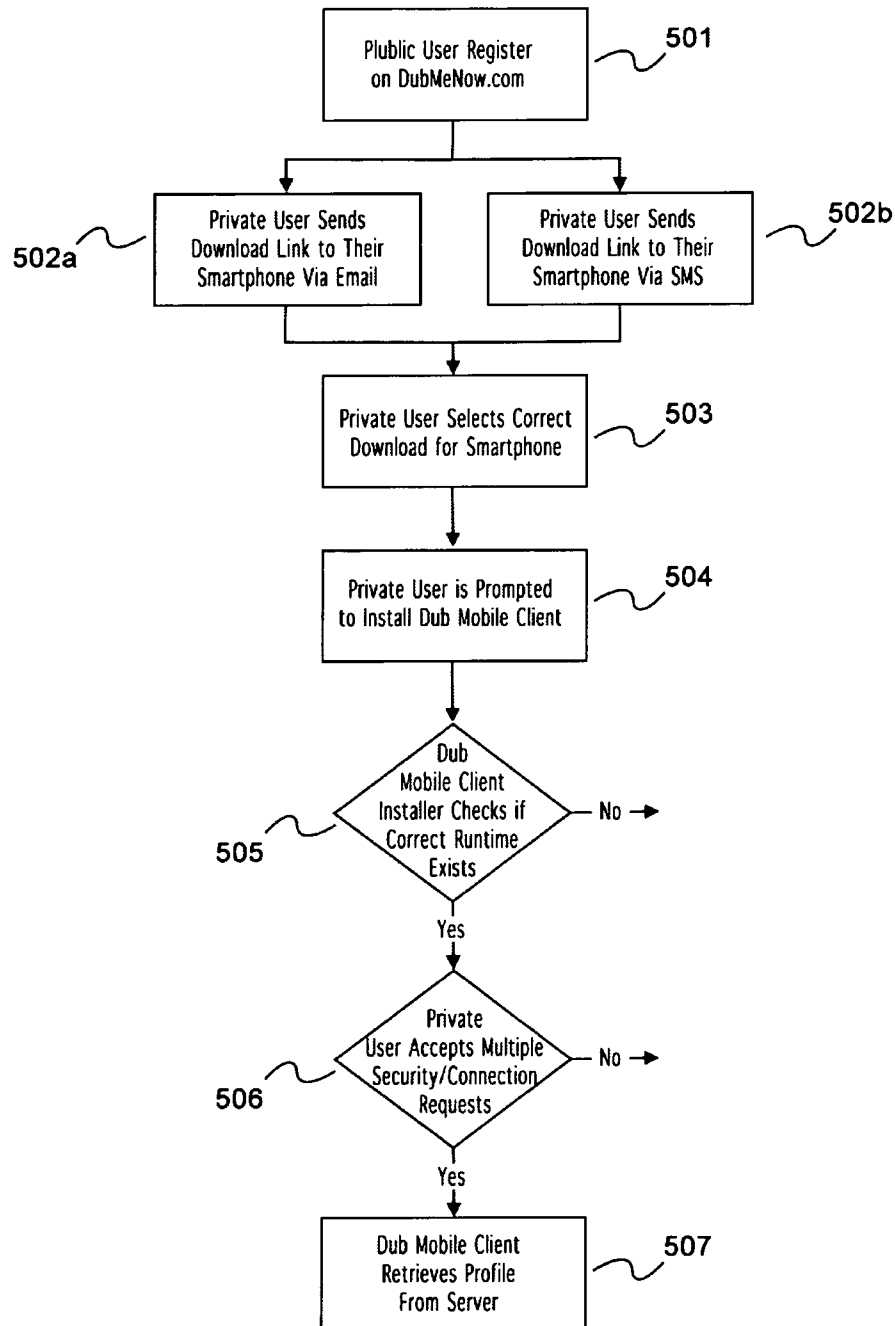

FIG. 5

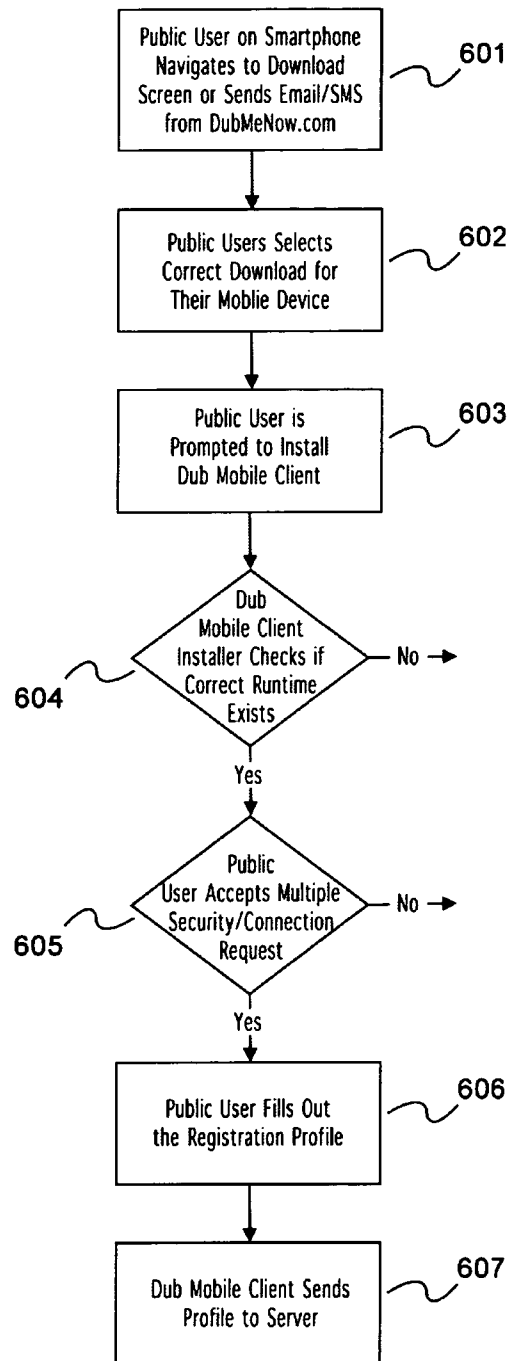

FIG. 6

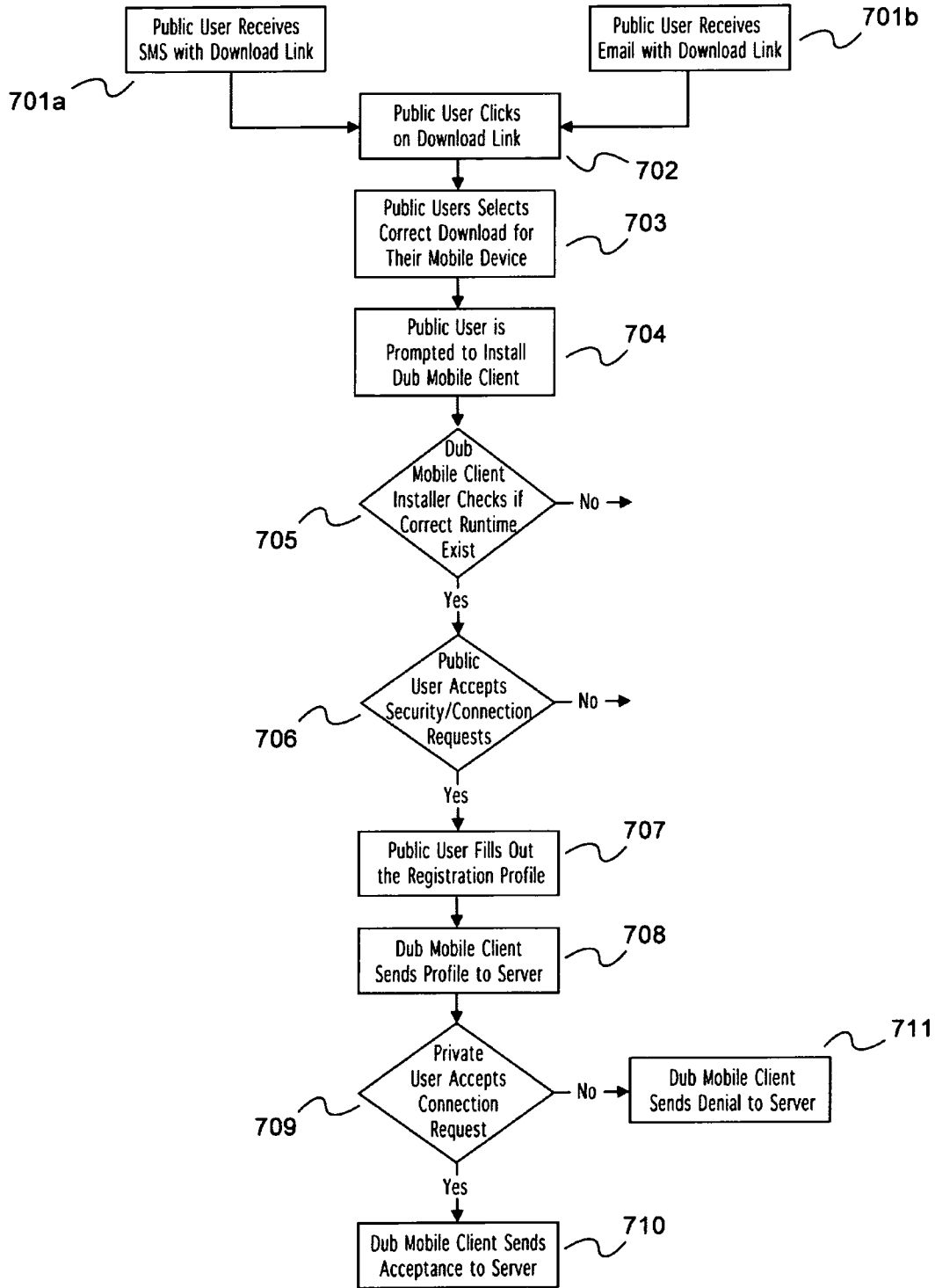

FIG. 7

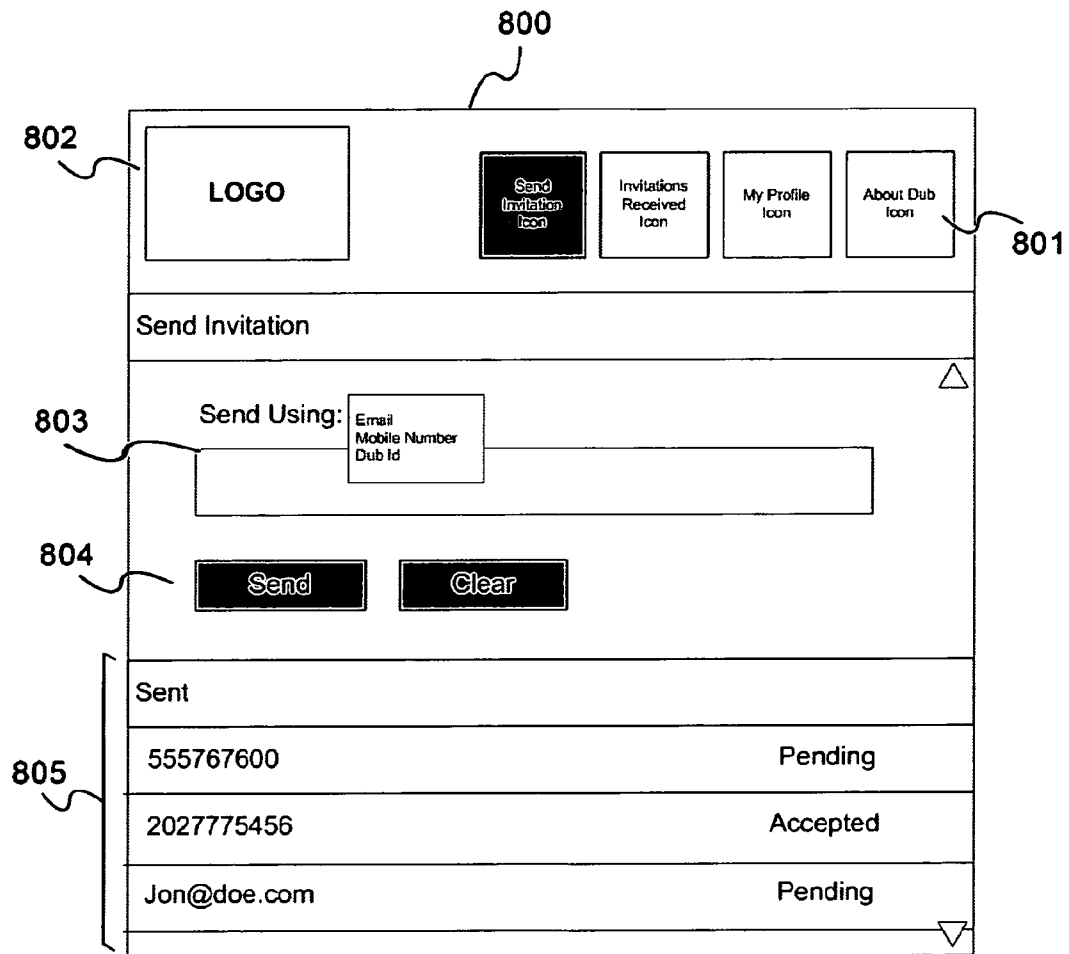

FIG. 8A

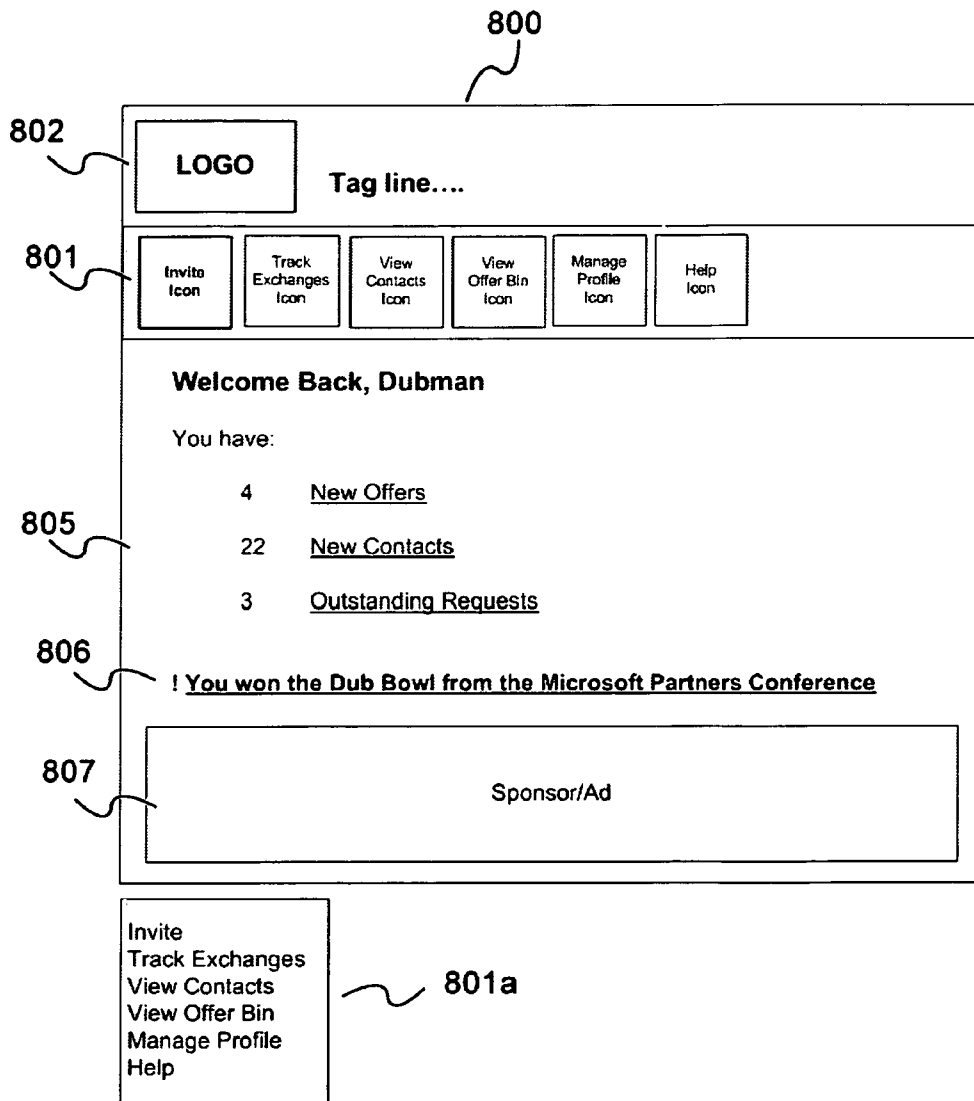

FIG. 8B

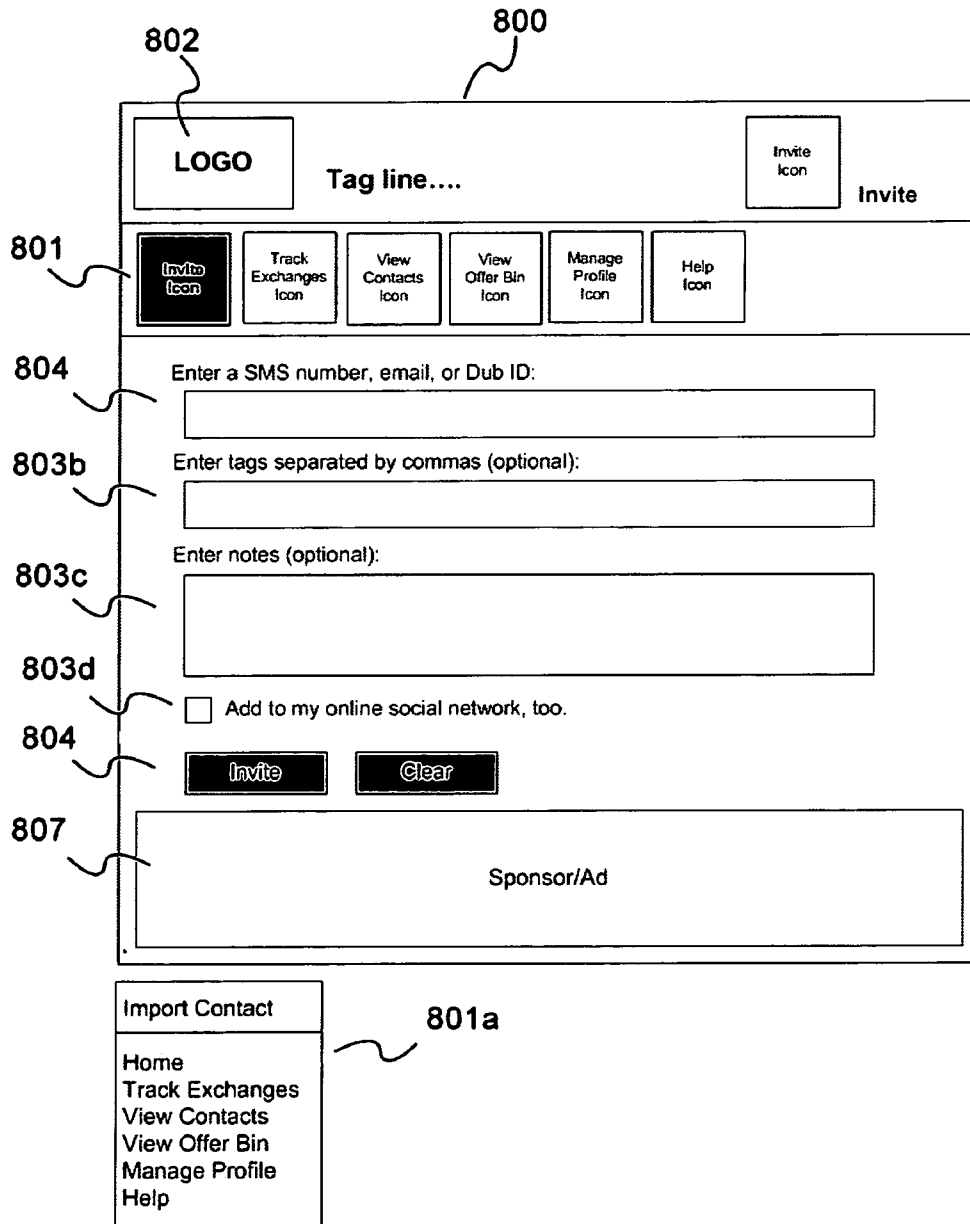

FIG. 8C

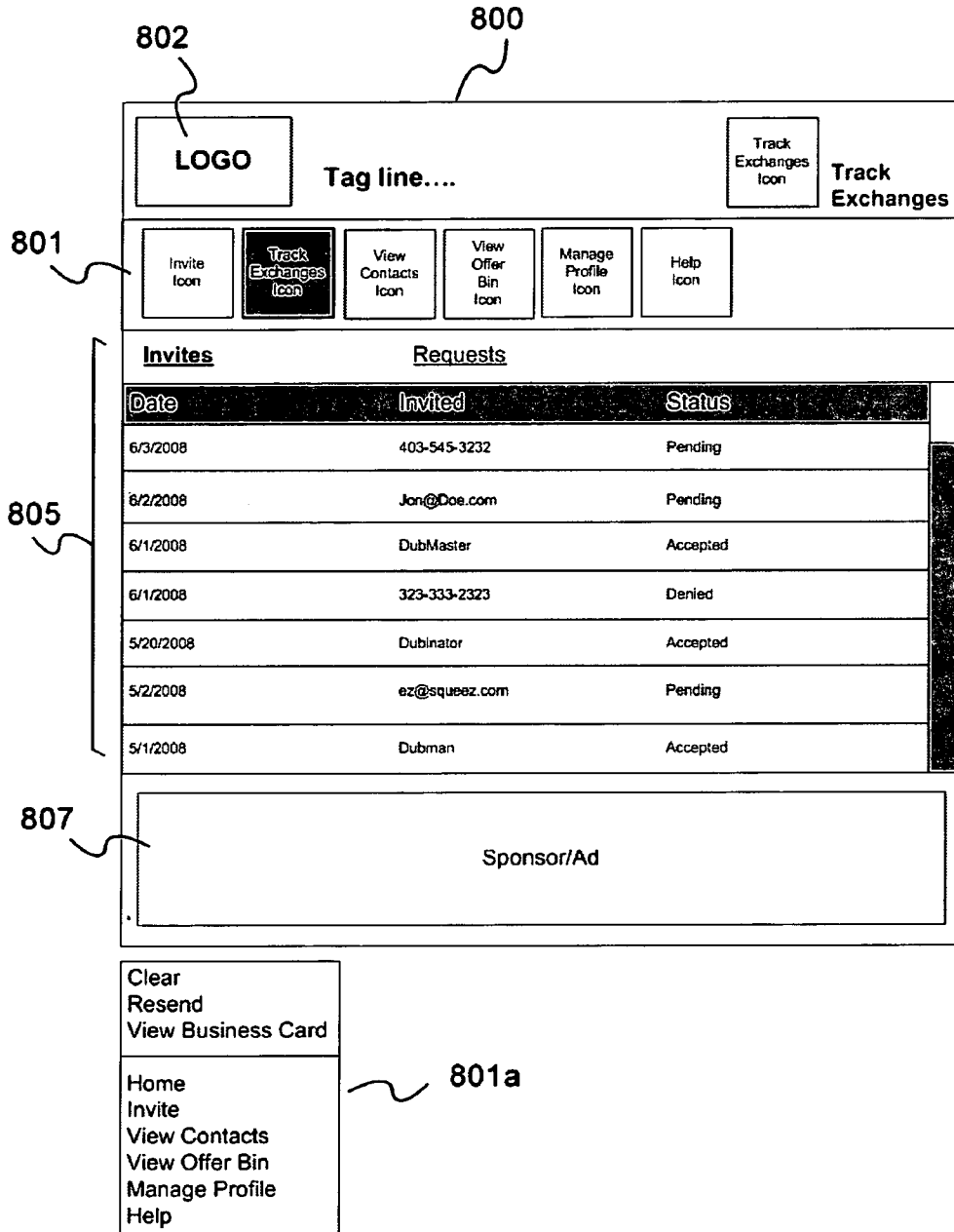

FIG. 8D

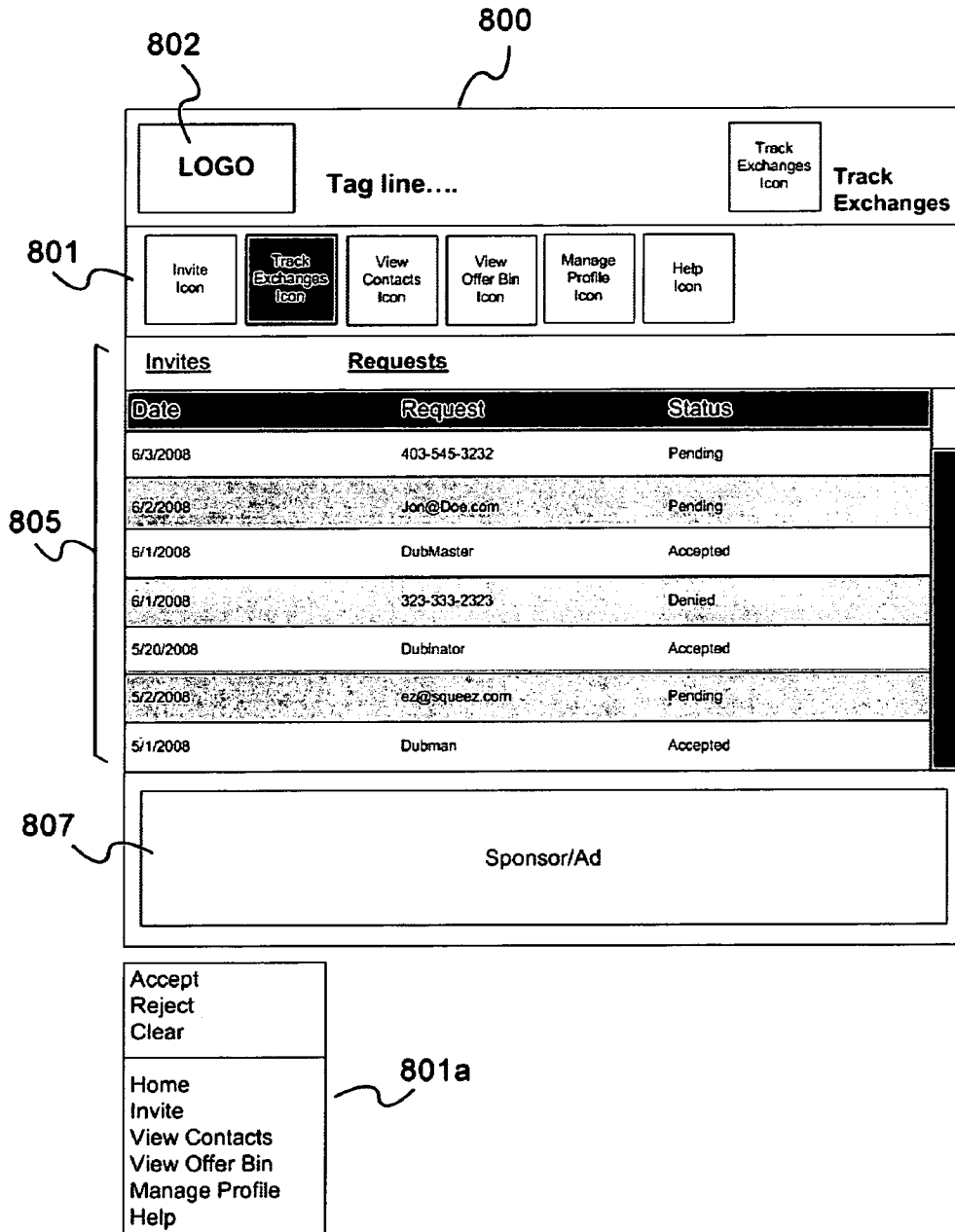

FIG. 8E

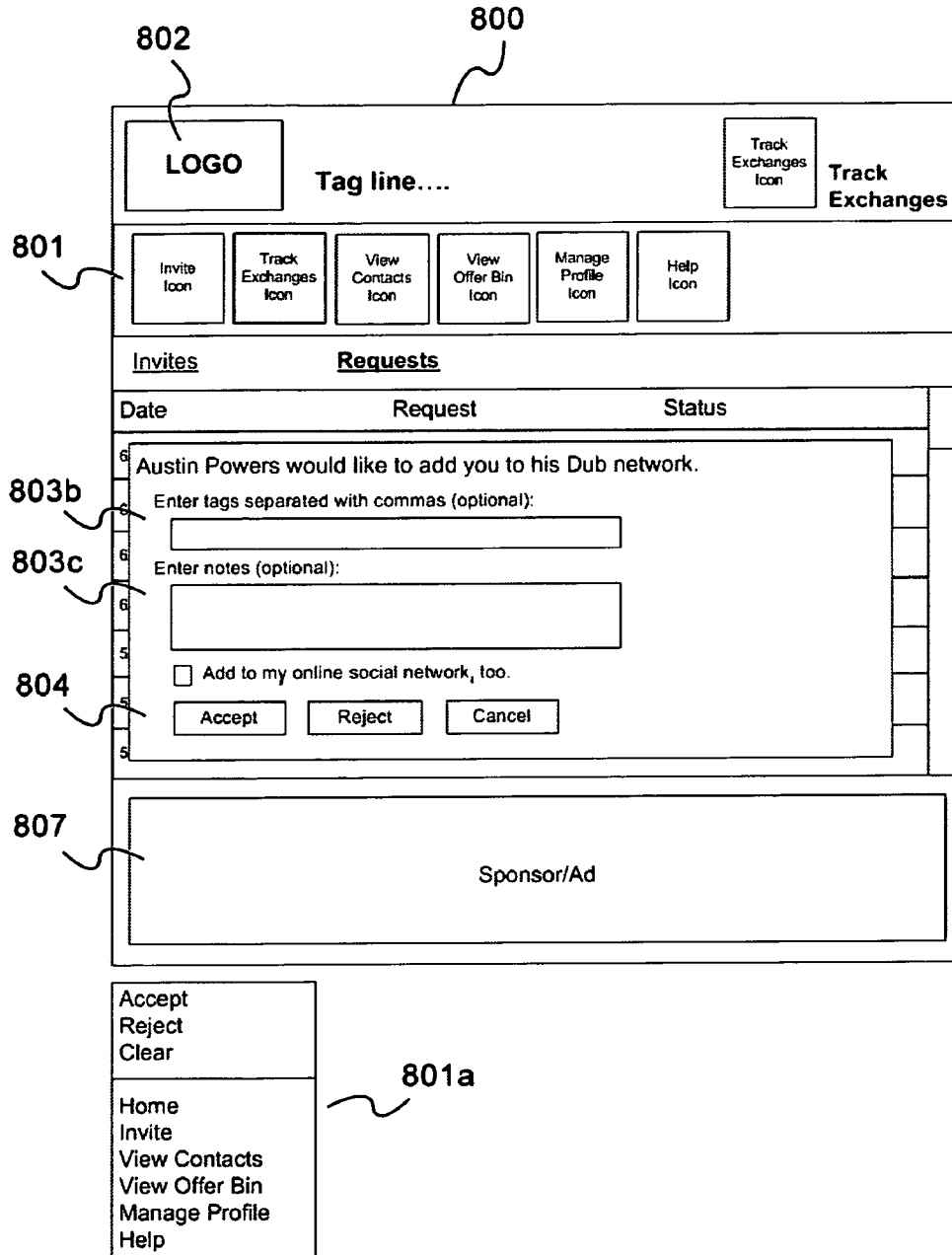

FIG. 8F

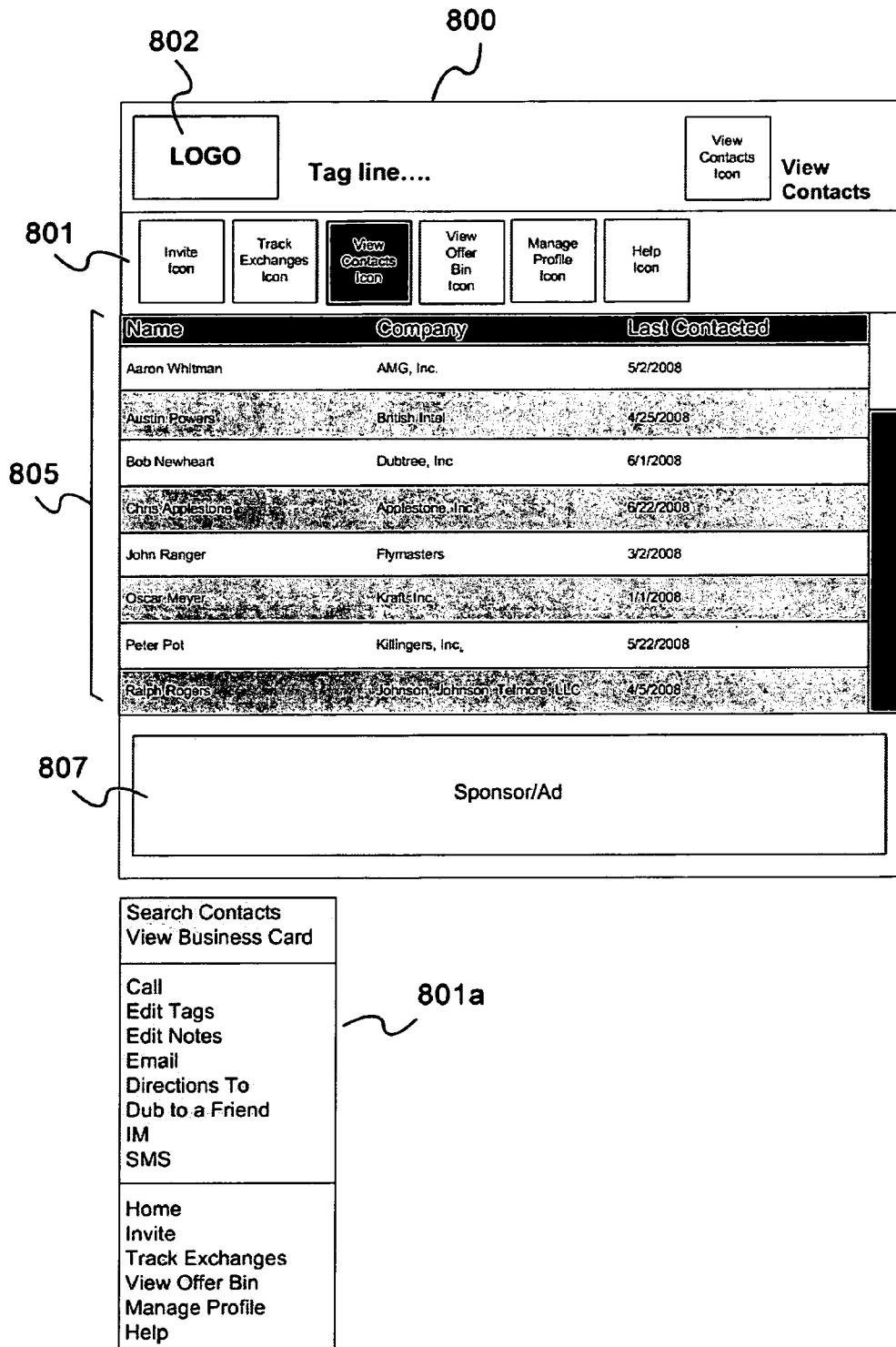

FIG. 8G

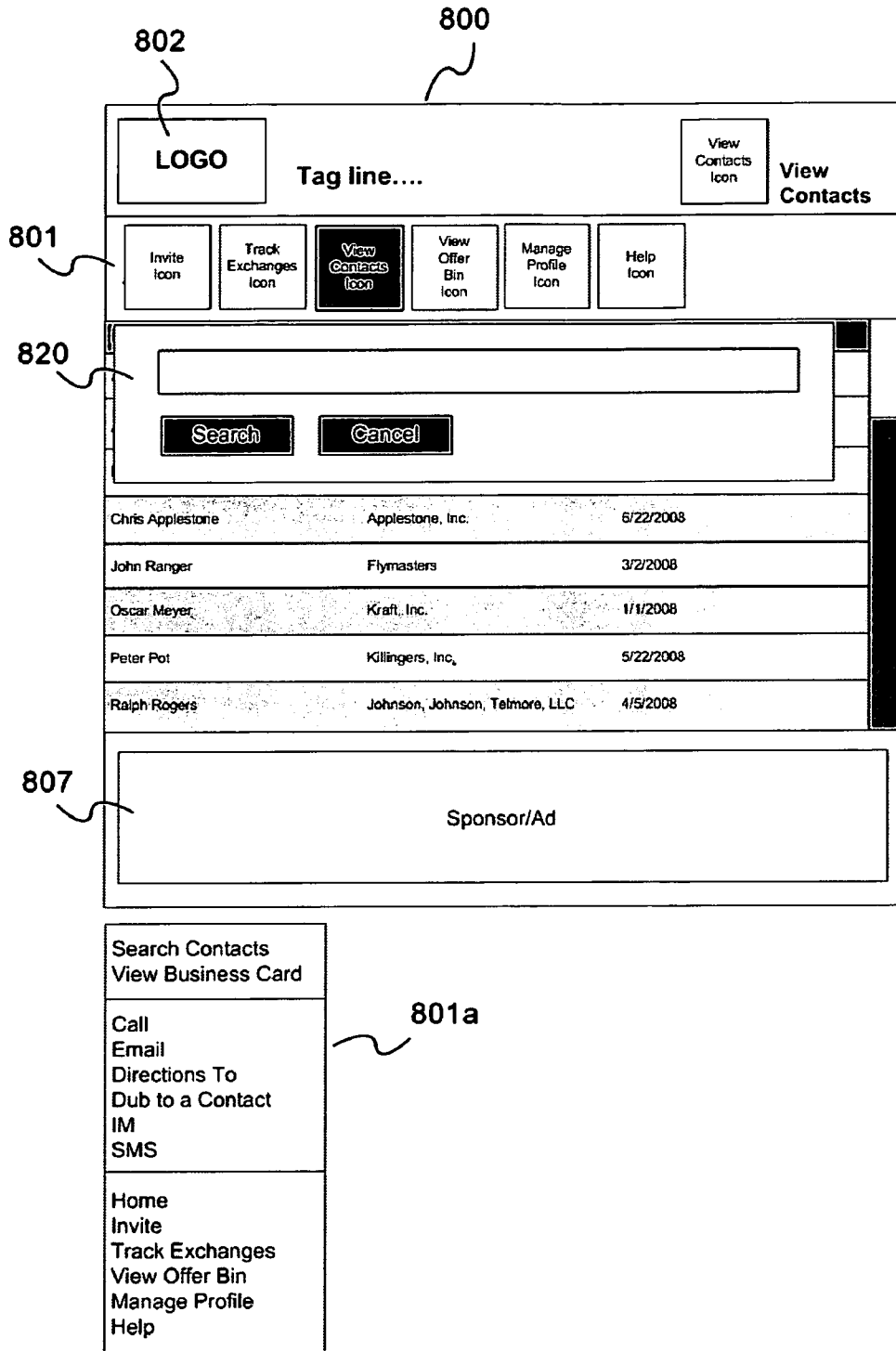

FIG. 8H

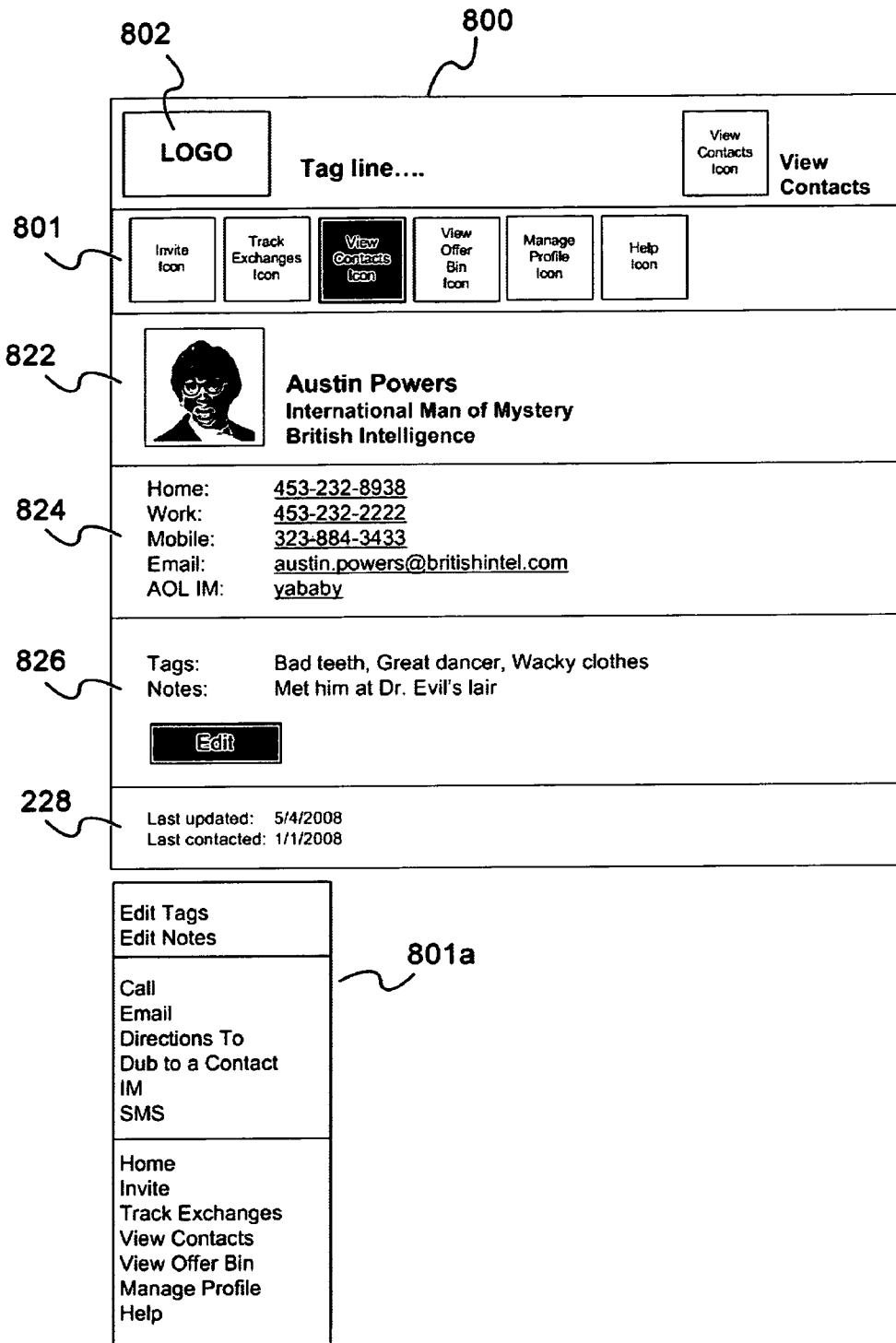

FIG. 8I

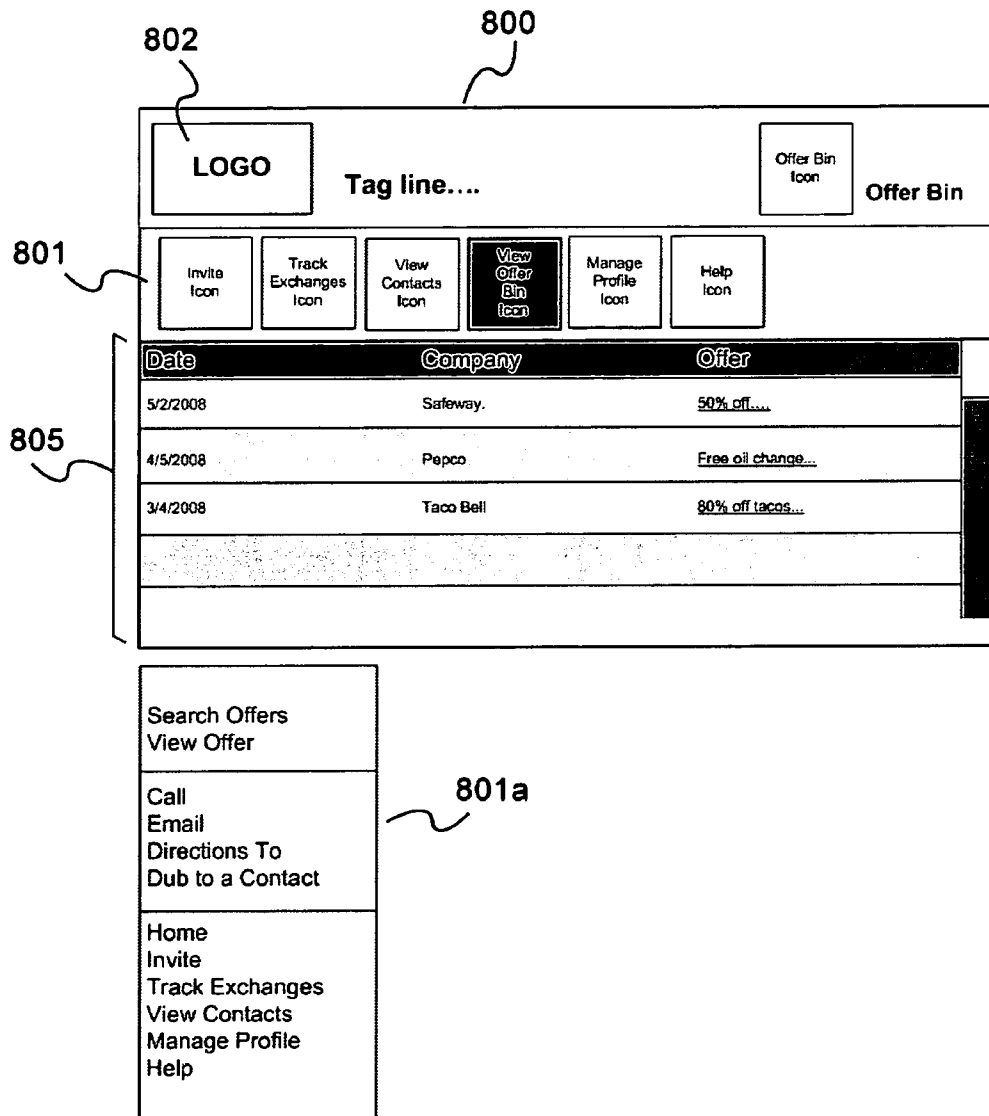

FIG. 8J

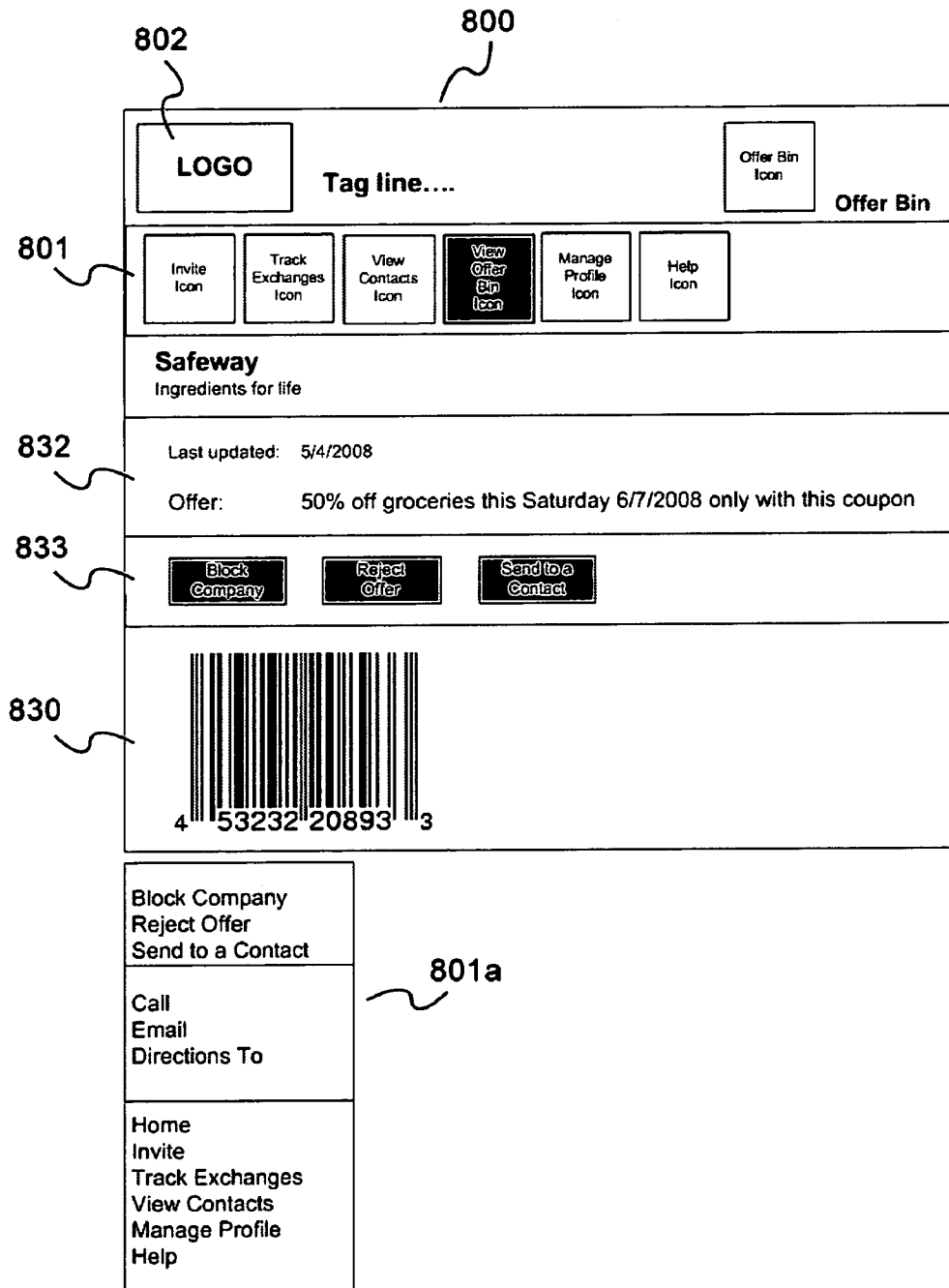

FIG. 8K

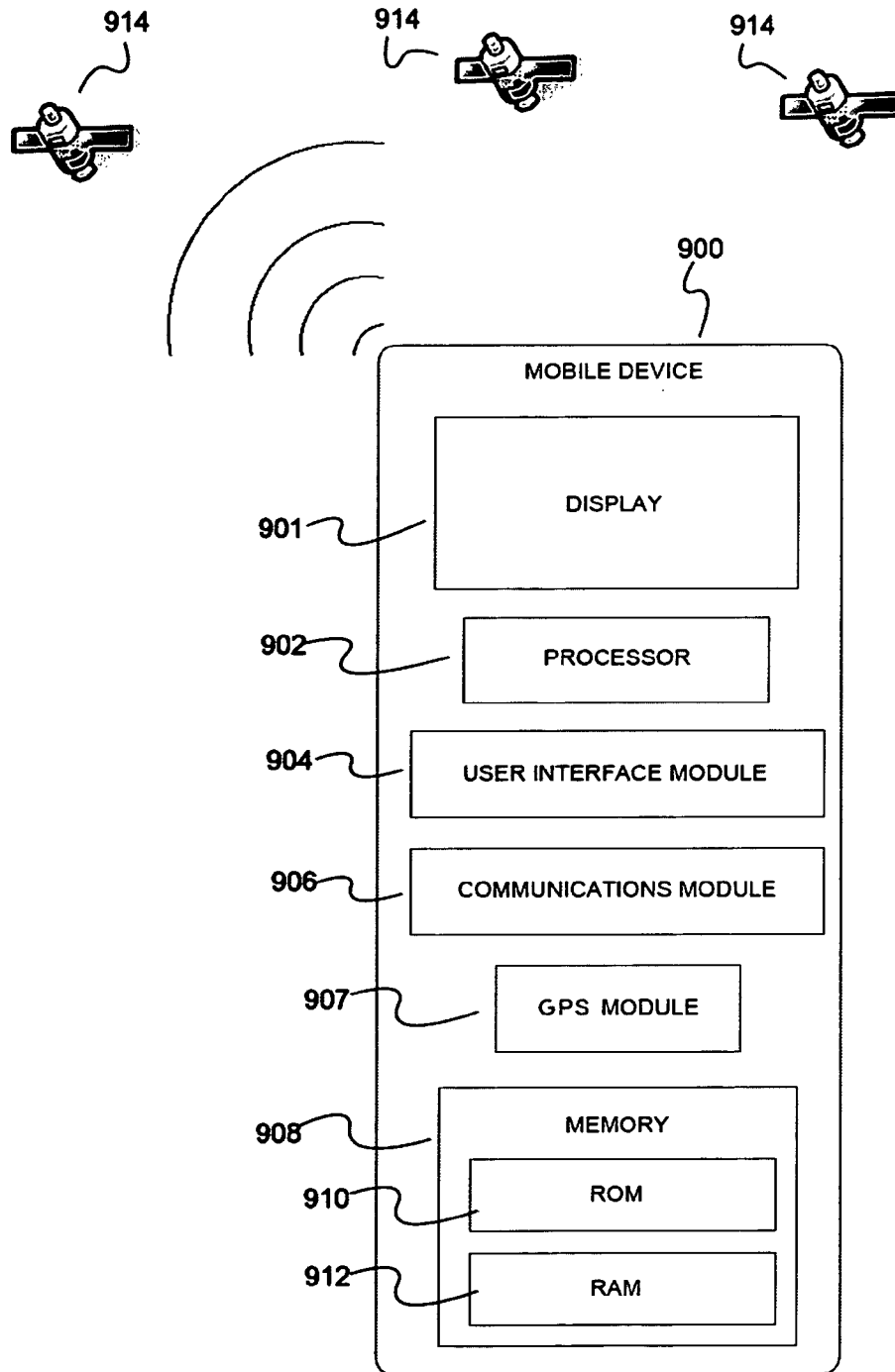

FIG. 9

1

AUTOMATIC PROFILE UPDATE IN A MOBILE DEVICE

CROSS REFERENCE TO RELATED APPLICATION

This application claims the benefit of the filing date of U.S. Provisional Application Ser. No. 61/080,697, entitled "AUTOMATIC PROFILE UPDATE IN A MOBILE DEVICE" filed Jul. 15, 2008, the entirety of which is incorporated herein.

BACKGROUND OF THE INVENTION

1. Field of the Invention

The invention, in general, relates to electronic business cards. More particularly, this invention relates to a method of exchanging electronic business cards through mobile phones between a user and contacts of the user. The contacts of the user may comprise personal and business contacts of the user.

2. Description of the Related Art

Electronically cataloging traditional business cards may be time consuming and prone to error. Business card information logged into an electronic contact management system may become obsolete over a period of time. The user may run out of the traditional business cards for exchange with the user's business contacts. The user may need to track relationship context along with the business card information of the user's business contacts to make note of context information such as place, time, relationship with a particular business contact, etc. The user may also need to send updates to the business card information of the user to user's business contacts in real time. The updates to the user's business card information may comprise a change in job profile, address, phone number or email address of the user. The user may also need to stay updated on the latest business card information of the user's business contacts at all times.

The user may also lose electronic business cards received from user's business contacts due to loss, malfunction, or replacement of the user's mobile device. Therefore, for an instance of loss of the electronic business cards, the user may need a backup of the electronic business cards of the user's personal and business contacts to retrieve the electronic business cards back on the mobile device of the user. The user may also want to send updated contact information to new business contacts through the user's mobile device automatically without user intervention. Existing online service providers' provide communication means to exchange business card information through web sites and electronic mails (emails), and business card scans stored on computer. The communication means provided by the existing online service providers may not capture the context of the exchange, for example, time and date of exchange, user notes, location, etc., nor may it capture social media information (e.g. blogs, LinkedIn, Facebook, or Twitter information). However, means to exchange the business card information instantly using mobile phones may not be provided by the online service providers.

Therefore, there is need for a method and a system that enables the user to exchange electronic business cards instantly through the user's mobile phone, share business card information (including social media information and context) with the user's business contacts, and capture context of meetings with the business contacts. There is also a need for the method and the system for storing the electronic business cards of the user's business contacts on a central server as a backup means. There is also a need for the method

2

and the system to automatically update modified business card information of the user's business contacts on the user's mobile device and vice versa.

SUMMARY OF THE INVENTION

This summary is provided to introduce a selection of concepts in a simplified form that are further described in the detailed description of the invention. This summary is not intended to identify key or essential inventive concepts of the claimed subject matter, nor is it intended for determining the scope of the claimed subject matter.

The method and system disclosed herein provides a mobile client on a requestor's first mobile device. The requestor provides requestor profile to an information exchange server through the mobile client. The requestor requests a connection with the recipient using the mobile client. The mobile client is provided on a recipient's second mobile device. The recipient provides recipient profile to the information exchange server through the mobile client. On acceptance of the request for connection by the recipient, the information exchange server transfers the recipient profile to the mobile client on the requestor's first mobile device and vice versa. The mobile client automatically updates the transferred recipient profile on the requestor's first mobile device based on changes made by the recipient to the recipient profile and vice versa.

BRIEF DESCRIPTION OF THE DRAWINGS

The foregoing summary, as well as the following detailed description of the invention, is better understood when read in conjunction with the appended drawings. For the purpose of illustrating the invention, exemplary constructions of the invention are shown in the drawings. However, the invention is not limited to the specific methods and instrumentalities disclosed herein.

FIG. 1 illustrates a method of managing mobile exchange of profile information between a requestor and a recipient.

FIG. 2 illustrates a system of managing mobile exchange of profile information between a requestor and a recipient.

FIG. 3A exemplarily illustrates mobile exchange of profile information between computing devices via a network.

FIG. 3B is an exemplary logical system architecture for the mobile exchange of profile information between computing devices via a network.

FIG. 4 exemplarily illustrates a flowchart of a process of a recipient installing a mobile client on a mobile device of the recipient based on request for connection by a requestor.

FIG. 5 exemplarily illustrates a flowchart of a process of a public user installing a mobile client on a smartphone.

FIG. 6 exemplarily illustrates a flowchart of a process of a public user installing a mobile client on a smartphone by accessing a host website from the public user's smartphone.

FIG. 7 exemplarily illustrates a flowchart of a process of providing a mobile client to a public user.

FIGS. 8A-8K exemplarily illustrate user actions performed by a user using a mobile client on a mobile device of the user.

FIG. 9 depicts an exemplary illustration of a mobile device.

DETAILED DESCRIPTION OF EXEMPLARY EMBODIMENTS

Particular embodiments of the present invention will now be described in greater detail with reference to the figures.

FIGS. 1-2 illustrate a method and system of managing mobile exchange of profile information between a requestor

201 and a recipient **203**. The profile information may comprise user name, contact numbers, email addresses, visual images, audio content, job profile, location addresses, and social media information and links, etc of the requestor **201** and the recipient **203** respectively. An electronic business card on a mobile device may collectively represent the profile information on a mobile device of the requestor **201** and the recipient **203** respectively.

Although the description refers to the requestor **201** as the party asking for the recipient's **203** profile information, it is to be understood that the requestor **201** and the recipient **203** may change roles, such that the recipient **203** may be the one asking for the requestor's **201** profile information. However, for clarity and to avoid confusion, the description will refer to the requestor **201** as the one asking for profile information from at least one or more other recipients **203**.

The method disclosed herein provides **101a** mobile client **202a** on a first mobile device **202** of the requestor **201**. The requestor **201** may download and install the mobile client **202a** from a host website via a network **205** onto the first mobile device **202**. The mobile client **202a** is compatible for installation on mobile devices working on different technological platforms and operating systems, for example, Java, Symbian, Windows, Mac, iPhone, Linux, Unix, Palm, etc.

The requestor **201** then provides **102** requestor profile **201a** to an information exchange server **206** of the host website through the mobile client **202a** via the network **205**. The requestor **201** may also use browser based computing devices to provide the requestor profile **201a** on the host website on the internet directly. The requestor **201** then requests **103** for a connection with the recipient **203** through the information exchange server **206** using the mobile client **202a** as shown in the user interface **800** of FIG. 8A. At box **803**, the requestor **201** may generate and send (at box **804**) the request as a short message service (SMS), an electronic mail (email), or through push notification (if the recipient is registered in the system the requestor may use the user ID of the recipient **203** instead of the SMS or email) via the information exchange server **206** to a second mobile device **204** of the recipient **203** using the mobile client **202a** as illustrated in FIG. 8A. The status of the various generated requests may be shown at box **805**. Various types of information may be included in the user interface **800**, such as active screen information (box **801**), or logos and or other types of advertisement information (at boxes **802**, **807**).

The request may be described as an "identification code" or ID code that initiates a set of instructions to be performed and controlled by the information exchange server **206**. Specifically, the identification code might contain an access code along with a key or hash function, a call to the specific API or API function, and/or any other type of required data to execute the appropriate function or functions. The function might consist of a profile transfer request to or from the recipient **203** or the requestor **201**, or any other function the user could perform through the mobile application. In one example, the access code and key may be a unique code and key which is established or loaded onto the mobile device **202**, **204** when the user first registers, logs in, or uses the mobile client on the mobile device **202**, **204**. In such an embodiment, the mobile device may provide the access code and key, and/or associated data information, to all transmissions along with the API request and appropriate data to provide the identity of the device, the user, and the appropriate instructions. The access code and key might also be a user name and password which are passed to the information exchange server **206** along with the API or instruction request and related data.

The identification code may be associated with various types of information, including but not limited to an access code, a key, a hash function, an API request or call, data required to perform the API request, information about the mobile device, location based information, a user, a user's preferences, the mobile device capabilities, profile information of a user, a social or professional event, a group, a centralized group coordinator, and any other type of data in accordance with this invention.

Another important aspect about the present invention is the ability for the system to obtain, pull, or retrieve information about the mobile device used by the requestor **201** or the recipient **203**. Such information might include the type of mobile device, platform and version, carrier information, profile information, and location based information. The system will know if a user changes mobile devices, the capabilities of the mobile device, if the user had updated software, or changes information about their mobile device. The profile and location data can be used to identify users about software upgrades, version conflicts, and location based services including internet access to GPS location of lost mobile devices.

In more detail, it is to be understood that various types of information may be made available to the information exchange server **206** during signaling in accordance with systems and methods of this invention, similar to the information exchanged when a mobile device registers (either as a push or a pull inquiry) with its serving network. At registration, and likewise when as here the mobile device signals into the network **208**, information about the particular device being used, such as the location of the mobile device, the user's profile, user preferences, and the like, may be shared with the information exchange server **206**. For various reasons, this information may be used by the information exchange server **206** to coordinate the type of messaging that should be prepared and sent to an intended mobile device recipient. For example, one user, and/or serving network for the mobile device of the user, may set a preference to receive SMS messages on his mobile device, while another user may prefer to receive email messages on their mobile device or at another device location. The information exchange server **206** is equipped to handle such translation and requests appropriately for the particular preference appropriately.

An "event" may be a one-to-one communication encounter, a one-to-many communication encounters, a social or personal meeting, and other engagement or environment in which contact profile information is generally exchanged amongst various people. Although the request is described above as a SMS or an email to communicate back to the information exchange server **206**, it is to be understood that any type of push or messaging protocol may be employed, including but not limited to, MMS, USSD, a dedicated short code, and or any other suitable messaging protocol capable of sending a request. The requestor **201** may also use other communications means, for example, infrared data transfer, Bluetooth, WiFi or WiMax, etc, to send the request to the recipient's **203** second mobile device **204**.

FIG. 8A depicts an exemplary user interface **800** on a first mobile device **202**. The user interface **800** includes selectable profile indicators **801** and a space for a logo **802**. As shown, the "Send Invitation Icon" is selected at **801**. A data entry box **803** is provided to insert the email, mobile number, a user id, or a message, and/or other types of information, and action buttons **804** are provided to send or clear the message in the data entry box **803**. Various status boxes **805**, **801a** are illus-

trated depicting the status of various invitations. The various FIGS. 8B-8K show similar user interfaces 800 including similar labels and indicia.

The information exchange server 206 then provides 104 the mobile client 202a on the recipient's 203 second mobile device 204 for acceptance of the request from the requestor 201. The information exchange server 206 may provide a hyperlink in an SMS or in an email sent by the requestor 201. The recipient 203 may click on the hyperlink in the SMS or the email for downloading the mobile client 202a on the recipient's 203 second mobile device 204. The recipient 203 may then download and configure the mobile client 202a on the recipient's 203 second mobile device 204. The recipient 203 then provides 105 the recipient profile 203a to the information exchange server 206 through the mobile client 202a on the recipient's 203 second mobile device 204.

The recipient 203 may accept the request from the requestor 201 through information exchange server 206 on the recipient's 203 second mobile device 204 as illustrated in FIG. 8F. On acceptance of the request by the recipient 203, the information exchange server 206 may establish the connection between the requestor's 201 first mobile device 202 and the recipient's 203 second mobile device 204. In one embodiment, the information exchange server 206 may establish the connection between the requestor 201 and the recipient 203 via the SMS or the email before the mobile client 202a is downloaded and configured by the recipient 203 on the recipient's 203 second mobile device 204.

On acceptance of the request from the requestor 201 by the recipient 203, the information exchange server 206 transfers 106 the recipient profile 203a and the requestor profile 201a to the mobile client 202a on the requestor's 201 first mobile device 202 and the recipient's 203 second mobile device 204 respectively. The information exchange server 206 first transfers 106a the recipient profile 203a to the requestor's 201 first mobile device 202. The information exchange server 206 then transfers 106b the requestor profile 201a to the mobile client 202a on the recipient's 203 second mobile device 204. Although the exchange of each of the requestor's 201 and recipient's 203 profile information 201a, 203a is being sent from the information exchange server 206, it is to be understood that profile information 201a, 203a may be sent directly between the first mobile device 202 and the second mobile device 204, without having to go through the information exchange server 206. In such instances, copies of the profile information 201a, 203a may be sent back to the information exchange server 206 to update the information exchange server's 206 profile information 201a, 203a records.

The mobile client 202a on the requestor's 201 first mobile device 202 may store the transferred recipient profile 203a of the recipient 203 as a recipient business card. The mobile client 202a on the recipient's 203 second mobile device 204 may also store the transferred requestor profile 201a as a requestor electronic business card. For example, the mobile client 202a on the requestor's 201 first mobile device 202 may update a requestor address book 202f on the requestor's 201 first mobile device 202 by storing the electronic business card of the recipient 203 in the requestor address book 202f.

The mobile client 202a then automatically updates 107 the transferred recipient profile 203a on the requestor's 201 first mobile device 202 and the transferred requestor profile 201a on the recipient's 203 second mobile device 204 based on changes made to the recipient profile 203a and the requestor profile 201a by the recipient 203 and the requestor 201 respectively. The recipient 203 may make changes to the recipient profile 203a on the information exchange server 206 using the mobile client 202a on the recipient's 203 second

mobile device 204. The recipient 203 may make the changes to the recipient profile 203a due to changes in one or more of job profile of the recipient 203, address of the recipient 203, phone number of the recipient 203, email address of the recipient 203, or any information or data stored or included in the recipient profile.

If the recipient 203 makes changes to the recipient profile 203a on the information exchange server 206, the information exchange server 206 may automatically transfer the changes made by the recipient 203 to the mobile client 202a on the requestor's 201 first mobile device 202. The automatic transfer may be in real time or near real time or pushed at logical intervals. For example, the mobile client 202a on the requestor's 201 first mobile device 202 and the information exchange server 206 may have a persistent internet protocol (IP) connection. The requestor 201 may then subscribe to receive the changes made by the recipient 203 automatically through the information exchange server 206 in real time. The mobile client 202a on the requestor's 201 first mobile device 202 may then automatically update the transferred recipient profile 203a on the requestor's 201 first mobile device 202 with the changes made by the recipient 203 to the recipient profile 203a. The mobile client 202a on the requestor's 201 first mobile device 202 may also automatically update the electronic business card of the recipient 203 with the changes to the recipient information in the requestor address book 202f of the requestor's 201 first mobile device 202. In addition, rather than a full time connection or periodic request, the system may employ a push technology or ping technology which acts when a profile is updated. The exchange server 206 upon receiving updated profile information would trigger an automatic push of the new information to the mobile device, with or without notification, or might ping the mobile device to accept the updated information.

Similarly, if the requestor 201 makes changes to the requestor profile 201a on the information exchange server 206, the mobile client 202a on the recipient's 203 second mobile device 204 may also receive the changes from the information exchange server 206. The mobile client 202a on the recipient's 203 second mobile device 204 may then automatically update the transferred requestor profile 201a on the recipient's 203 second mobile device 204 automatically with the changes made by the requestor 201 to the requestor profile 201a. The mobile client 202a on the recipient's 203 second mobile device 204 may also automatically update the electronic business card of the requestor 201 with the changes to the recipient information in the recipient address book 204a of the recipient's 203 second mobile device 204. The requestor 201 and the recipient 203 may also update one or more personal and business contacts selectively on the requestor's 201 first mobile device 202 and the recipient's 203 second mobile device 204 respectively. The mobile client 202a on the requestor's 201 first mobile device 202 and the recipient's 203 second mobile device 204 may also send requests to the information exchange server 206 at predefined intervals to automatically receive the changes to the recipient profile 203a and the requestor profile 201a respectively.

The requestor 201 may have access to the recipient profile 203a of the recipient 203 on one or more of the social network websites. The requestor 201 may then import and store the recipient profile 203a of the recipient 203 from the social network websites directly onto the requestor's 201 first mobile device 202 through the mobile client 202a on the requestor's 201 first mobile device 202. The information exchange server 206 may then automatically establish a connection between the requestor 201 and the recipient 203 when the requestor 201 imports and stores the recipient profile 203a

on the requestor's **201** first mobile device **202** using the mobile client **202a**. The recipient **203** may also import and store the requestor profile **201a** of the requestor **201** from the social network websites directly onto the recipient's **203** second mobile device **204** through the mobile client **202a** on the recipient's **203** second mobile device **204**. The mobile client **202a** on the requestor's **201** first mobile device **202** may also add (box **803d** of FIG. **8C**) or update the recipient profile **203a** of the recipient **203** on one or more social networking websites on the internet with the transferred recipient profile **203a**. The mobile client **202a** on the recipient's **203** second mobile device **204** may also add or update the requestor profile **201a** of the requestor **201** on one or more social networking websites on the internet with the transferred requestor profile **201a**.

The first mobile device **202** and the second mobile device **204** may be any of the commercially available mobile phones and smartphones, for example, Blackberry, Palm, Nokia, Ericsson, Samsung, Android, iPhone, and/or any other commercially available mobile phone now known or later discovered in accordance with this invention. The requestor **201** and the recipient **203** may further create multiple profiles on the host website via the internet or via the mobile client **202a** to provide context specific information. For example, if the recipient **203** is a friend or a family member of the requestor **201**, the requestor **201** may create a personal profile to provide personal information to the recipient **203**. If the recipient **203** is a business associate of the requestor **201**, then the requestor **201** may create a business profile to provide business information to the recipient **203**. The requestor **201** and the recipient **203** may tag context specific information (boxes **803b**, **803c** of FIG. **8C**) along with the requestor profile **201a** and the recipient profile **203a** respectively as illustrated in FIG. **8C**. The context information may comprise the location where the contact was made, the time the contact was made, shared interests and/or groups with the contact, personal and business notes, links to clients, and any other type of information intended to be memorialized about the contact. For example, the context information may comprise information noting the recipient **203** as a smart sales person or a known manager of a company. The mobile client **202a** may also capture an image or image data such as a picture of the recipient to add to the recipient profile **203a**.

The mobile client **202a** may capture geographic information like date, time, and global positioning system (GPS) coordinates at the time of providing the requestor profile **201a** and the recipient profile **203a** by the requestor **201** and the recipient **203** respectively. The mobile client **202a** may then send the captured date, time, and GPS coordinates to the information exchange server **206**. The information exchange server **206** may store the requestor profile **201a** and the recipient profile **203a** provided by the requestor **201** and the recipient **203** respectively. The information exchange server **206** may also store the geographic information sent by the mobile client **202a**.

The method disclosed herein further provides an electronic business card bowl application **208** for a business organization **207** with a business profile provided on the information exchange server **206** for collecting the profile information provided by customers using the mobile client **202a** via the information exchange server **206**. The method disclosed herein may provide an exclusive online business service to the business organization **207** to set up the electronic business card bowl application **208** on a business website of the business organization **207**. The electronic business card bowl application **208** may store the profile information provided by the customers on a business website of the business organi-

zation **207**. For example, the business organization **207** may receive profile information from the customers through the electronic business card bowl application **208** via the information exchange server **206**. The business organization **207**, for example, a chamber of commerce, business alliance, an association, a membership or club, a restaurant, a garment shop, a retail outlet, etc may then utilize the electronic business card bowl application **208** for ease of profile information transfer to attendees and for promotions of the business organization **207**. For example, all the attendees of a given event or conference of the organization may be provided in a group or organization listing in the database **306** which would be available to other attendees through the information exchange server **206**. Further, the business organization **207** may utilize the list of attendees such as for a contest offering prizes to the attendees or customers using the profile information of the attendees or customers stored by the electronic business card bowl application **208** through the information exchange server **206**. An attendee or customer may send their profile to the business organization **207** through the mobile client **202a** on a mobile device of the customer via the information exchange server **206** to avail business offers offered by the business organization **207**. The business offers may comprise exchange of profile information of other attendees, notification mailing list entry, contest for free lunch, discount coupons, etc offered by the business organization **207**.

The mobile client **202a** enables the requestor **201** and the recipient **203** to view the user interface **800** of the mobile client **202a** as illustrated in the status box **805** in FIG. **8B**, send the requests, accept the requests, view status of the sent requests or invites as illustrated in the "Track Exchanges Icon" user interface **800** shown in FIG. **8D**. FIG. **8E** shows a user interface **800** in which the requests received may be viewed in status box **805** as illustrated in FIG. **8E**. The mobile client **202a** also enables the requestor **201** and the recipient **203** to view list of contacts as illustrated in the user interface **800** illustrated in FIG. **8G**. Using search query box **820** within the user interface **800**, FIG. **8H** illustrates how a particular contact may be searched for within a list of contacts, as well as to view and update the profile information, etc. In the user interface **800** shown in FIG. **8I**, the mobile client **202a** also enables the requestor **201** and the recipient **203** to view the profile information **822** of a particular contact, e.g., Austin Powers. As shown in this exemplary user interface **800**, the contact profile information includes various types of information. In a first contact information identification box **822**, along with the contacts name, company and position may be displayed. In a second box **824**, various phone numbers, email, social networks and IM addresses may be displayed. In another box **826**, other contextual information and private notes may be provided about the contact. This profile information may be accessed via the Internet and/or through the mobile client **202** on a requestor mobile device **202**. At box **228**, information about recent updates and last contacts with the person may be provided. Any one of the boxes, and or information in any of the FIGS. **8A-8K** may be expanded to include an extensible set of icons and customizable links. As depicted in the user interface **800** shown in FIG. **8J**, business offers sent from advertisers may be viewed, and accept or rejected. FIG. **8K** depicts another exemplary view for the user interface **800** in which additional business offers sent from advertisers may be reviewed in status box **805**.

The requestor **201** and the recipient **203** may also use browser based computing devices to access an user interface similar to the mobile client **202a** provided on the host website of the information exchange server **206** via the internet by registering on the host website and logging in. The mobile

client **202a** on a mobile device may maintain a log of calls, emails, text messages, etc. sent from the mobile device of the user. The information exchange server **206** may also store the log of calls, emails, text messages, etc. sent from the mobile device of the user in an information database **206a** of the information exchange server **206**. The mobile client **202a** may provide the user an optional offer bin facility for receiving advertisements from advertisers on the user's mobile device. The mobile client **202a** may enable the user to send the profile information with the other users without disclosing phone number of the user. The mobile client **202a** also enables the user to maintain a back up of the profile information of the other users on the user's mobile device in the information database **206a** of the information exchange server **206**. The user may retrieve the back up of the profile information of the other users from the information database **206a** through the information exchange server **206** in case of loss or damage of the user's mobile device.

FIG. 2 illustrates a system of managing mobile exchange of profile information between a requestor **201** and a recipient **203**. The system disclosed herein comprises a mobile client **202a** provided on a requestor's **201** first mobile device **202**, a recipient's **203** second mobile device **204**, and an information exchange server **206** connected via a network **205**. The mobile client **202a** comprises an information input module **202b**, a request module **202c**, information update module **202d**, and an offer bin module **202e**. The information input module **202b** enables the requestor **201** and the recipient **203** to provide requestor profile **201a** and recipient profile **203a** respectively to an information exchange server **206**. The request module **202c** requests for a connection with the recipient **203**.

The information exchange server **206** comprises an information database **206a** and an information transfer module **206b**. The information database **206a** stores the requestor profile **201a** and the recipient profile **203a** provided by the requestor **201** and the recipient **203** respectively through the mobile client **202a**. The information database **206a** also stores a log of calls, emails, and text messages sent from a mobile device using the mobile client **202a**. On acceptance of the request for the connection from the requestor **201** by the recipient **203**, the information transfer module **206b** transfers the recipient profile **203a** from the information exchange server **206** to the requestor's **201** first mobile device **202**. The information transfer module **206b** then transfers the requestor profile **201a** to the mobile client **202a** on the recipient's **203** second mobile device **204**. The information update module **202d** of the mobile client **202a** on the first mobile device **202** automatically updates the recipient profile **203a** and the requestor profile **201a** transferred from an information exchange server **206** on the requestor's **201** first mobile device **202** and recipient's **203** second mobile device **204** respectively based on changes made to the recipient profile **203a** and the requestor profile **201a** by the recipient **203** and the requestor **201** respectively. The mobile client **202a** may update an electronic business card of the requestor **201** and the recipient **203** in a requestor address book **202f** of the requestor's **201** first mobile device **202** and a recipient address book **204a** of the recipient's **203** second mobile device **204** respectively. The offer bin module **202e** receives advertisements from advertisers on the mobile device using the mobile client **202a**.

The system disclosed herein further comprises an electronic business card bowl application **208**. The electronic business card bowl application **208** collects profile information provided by customers via the information exchange

server **206** on a business website of the business organization **207** hosted by a business organization server.

FIG. 3A depicts an exemplary illustration of an exchange of profile information between various computing devices via the network **205**. As shown, a browser based user **301a** is shown using a computing device **302**, a mobile browser based user **301b** is shown using a mobile device **303**, and a mobile rich client user **301c** is shown employing a smart phone **304** which may be connected through a web server **307** into one or more information exchange servers **308** via the network **205**. Although each of the various computing devices **302**, **303**, **304** shown are connected through one of various users **301a**, **301b**, **301c** interfaces, it is also within the scope of this invention to connect a mobile computing device into the information exchange servers **308** via a native user interface, and/or any other interface which does not require a web server **307**. Although not specifically depicted, a mobile user (such as **301b**) could be connected or interact with the system through use of SMS. In such an instance, the user would send an SMS message to one or more SMS codes with established instructions. For example, the mobile user **301b** could send an SMS text to 38263: dubme john@myemail.com. The SMS message would be transmitted from the carrier to the system where it could be translated into http requests to interact with the API, servers **307**, **308** and database **306** to execute the same functions and requests the user can employ through the mobile client **202a**. In this instance, the instructions would be translated into an http request to interact with the API to transmit the user's profile to the recipient whose email is john@myemail.com.

Each of the user **301a**, **301b**, **301c** interfaces may access data via a database server **308** from the information exchange servers **308** in a simple and clear format. According to this system, the addition of a new user interface can be integrated in an easy, suitable manner. As shown and in FIG. 3B, the architectural style is layered, and the logical architecture of the system is depicted from at least one mobile phone user interface down to the source database. It is to be understood that the layered architectural structure of this system may include more or less layers in accordance with this invention.

FIG. 3A depicts an exemplary logical system architecture illustration in accordance with this invention. The object of this architecture is to coordinate the transfer, extraction, storage and representation of data information to and from the existing legacy systems, the exchange servers of this invention, and the various computing devices **302**, **303**, **304** operated by the various users **301a**, **301b**, **301c**. FIGS. 3A and 3B show a system including at least three different users **301a**, **301b**, **301c**. The various interfaces may run on any one of, or many, number of different operating systems, including but not limited to Windows®, Linux, WAP, MIDP, Symbian, Pocket PC, and or any other platform now known or later discovered in accordance with this invention.

In FIG. 3A, the web servers **307** communicate with one or more storage databases, such as the database servers **308** and a proprietary database **306**, such as herein named and shown "DUB Database." The web servers **307** handle the HTTP protocol to enable the exchange of the profile information between the storage databases **306**, **308**, the browser-based user **301a**, the mobile browser-based user **301b**, the mobile rich client user **301c** via the Internet. As previous described, the user could interact with the system through SMS or an SMS client on the mobile device send SMS messages to the network which are then converted into http requests. Likewise, the web servers **307** provide the interface capability for sending the email and/or SMS to the browser-based user **301a**, the mobile browser-based user **301b**, and the mobile

rich client user **301c** via the internet or the network **205** can be used to send SMS messages to mobile devices which are set to receive SMS through user preference or mobile device limitations. The web servers **307** also provide the capability of pushing updated application code or profile information to the browser-based user **301a**, the mobile browser-based user **301b**, and the mobile rich client user **301c** via the internet.

In FIG. 3B, the mobile application **350** communicates into the core application **320**. As depicted, the web application **330** and a mobile web application **340**, are connected to and between the mobile application **350** and the core application **320**. As shown, the web application **330** is composed of a web presentation layer (WPL) **332**, and the mobile web application **340** is composed of a mobile web presentation layer (MWPL) **342**. Both of these applications transform and represent the profile information in a manner in which the target mobile device can handle and eventually display the profile information on a user interface to the user.

According to this invention, it is to be understood the API's integrated herein provide both front end and back end APIs for integration. For front end integration, REST/JSON APIs and SDK may be provided for iPhone, BlackBerry, Windows Mobile, Android, and other similar operating mobile devices. A Javascript library may also be available to integrate the systems and methods of this invention with Web-based interfaces. On the backend, this invention may integrate an asynchronous integration pipeline that ties outbound requests off its invitation, or connection process. Various pre-built providers (e.g., Salesforce, LinkedIn, Siebel, SugarCRM, Twitter) may be leveraged, or customized applications may be developed and integrated. Likewise, organizations can push data from their systems and the methods described in this invention enable data n information within the present invention to be pushed into other organization systems seamlessly.

Communication to and from the web application **330** and the web presentation layer (WPL) **332** may leverage representational state transfer (REST) as a preferred software architecture style for distributed hypermedia systems such as the World Wide Web. However, it is to be understood that any suitable architecture style may be implemented in accordance with this invention. As shown, the MIME type of the data supported by the web service is JSON. However, other suitable types may include, such as for example, XML, YAML, and or any other valid MIME type, now known or later contemplated in accordance with this invention. The semantics of REST notifications can easily be expressed in JSON format and are easy to parse and handle in the JavaScript environment. In this example, both of the UIs are browser-based, however, as mentioned before, it is also possible to choose to implement native or alternative wireless UIs, and/or the like which may not be browser based. Adding a new interface into this architecture could be accomplished through the addition of a new component at the presentation layer.

In the core application **320**, various components are provided including data storage **322**, a core data layer (CDL) **324**, and a core application services layer (CASL) **326**. Together, the various components provide the requisite logic and applications for processing the data and providing the profile information data to the user interface of the mobile devices **302**, **303**, **304** for the various users **301a**, **301b**, **301c**.

In the mobile application **350**, various other components are provided including a mobile services layer (MSL) **351**, a mobile application layer (MAL) **352**, and a mobile presentation layer (MPL) **353**. The mobile services layer (MSL) **351** exchanges data information with an SMS client **354**, an email client **355**, a push client **356** and an address book **357** resident in the mobile application **350**. It is to be understood that the

mobile application **350** is adapted to host various additional clients not shown, albeit readily available. Together, the various layers **351**, **352**, **353** in the mobile application **350** include the requisite logic and support applications to process the data to and from the core application **320** in order to provide the profile information data to the various users **301a**, **301b**, **301c**.

As shown in FIG. 3B, various services may communicate and exchange data information between the core application services layer **326** and the various clients **354**, **355**, **356** in the mobile application **350**. By way of example, an SMS/Text client **362** resident on the mobile phone **360** communicates from a carrier **376** and through an SMS gateway **374** and/or through an email server **378** back into the email client **355** or the SMS client **354** within the mobile application **350**. Alternatively, where a push type service **379** is used on a mobile computing device, such as with Apple and RIM products, text generated from the SMS text client **362** would be transmitted into the push client **356** within the mobile application **350**. Although SMS and email are described in detail, it is to be understood that any type of suitable messaging format may be integrated in accordance with this invention, such as for example, short codes, MMS, USSD and/or any other suitable messaging service now known or later discovered.

In FIG. 3B, various other services are shown integrated into the systems and methods of this invention, such as, for example, the integration of a customer relationship management (CRM) contact management system **370**, and/or the social networks **372**. Data information gathered from the CRM contact management systems **370** and the social networks **372** may be sent into the core application services layer (CASL) **326**. As shown, a location based service (LBS) **380** may be integrated into this invention. The LBS system **380** can provide information about the current position of a mobile device, as well as comparison and relative data of two mobile devices in proximity with each other. Various commercially available location based services may be used, such as for example, GPS, cell tower triangulation techniques, and any other suitable position locating technology.

The CRM contact management system **370** may be used in combination with the systems and methods of this invention in such a way that proprietary sales data information about a carrier's vendors and their partners may be securely shared with a proprietary sales person in the carriers **376** employ. In more detail, an aspect of this invention is to allow the carrier employee access to carrier's client database while under carrier's employ. However, carte blanche access may not be desired by the carrier. Consequently, certain identity information about the carrier's proprietary contact information may be masked so that if the employee should leave the carrier's employ, the carrier employee will be disconnected from acquiring access to the carrier client database, as well as lacking the ability to further access the carrier's client database. It is to be understood that various types of contact managements systems may be employed, such as, Siebel on Demand, Sales Force, as well as other contact management databases such as LinkedIn, MS Dynamics, Twitter, MySpace, and any other now known or later discovered contact management database.

The Location Based Service **380** element can operate in a variety of different ways. According to a first embodiment, a one-to-one social encounter may take place in which a requestor **201** and a recipient **203** encounter each other. Although the one-to-one social encounter has been described in detail with respect to FIG. 2, an additional aspect of this scenario is such that the location based service **380** may be integrated into the one-to-one encounter. This feature would

allow a requestor **201** and a recipient **203** having a mobile client **202a** installed on each of their phones respectively, to exchange profile information without the need to manually enter an email address, an identification code or a phone number. Employing the location based service **380**, equipped for example with GPS or cell tower triangulation techniques, and within predetermined time interval, the information exchange server **206** may match and compare incoming exchange requests and present participating users with a list of available participating users. That is, where the requestor **201** and a recipient **203** desire to share profile information **201a**, **203a**, both the requestor **201** and the recipient **203** may initiate the exchange of their profile information nearly simultaneously by, for example, selecting an assigned button on their respective mobile devices **202**, **204**. LBS **380** may then determine whether the requestor **201** and the recipient **203** are proximally close to each other and have both selected to share their profile information at approximately the same time with each other. The need to identify and associate a specific ID code with the encounter may not be necessary because the LBS **380** may determine that since the first mobile device **202** and the second mobile device **204** are substantially close to each other and have both selected to share profile information with another mobile device in close proximity to them, the likelihood that they are both requesting each others profile information is highly certain. The information exchange server **206** can send a verifying message to both the first mobile device **202** and the second mobile device **204** requesting verification that they desire to exchange profile information with each other. Upon acceptance, the requestor profile **201a** and the recipient profile **203a** may then be exchanged with each other wirelessly. Although described as a one-to-one encounter, it is also possible to implement this process in a group setting where more than one mobile device is available to share each of their respective profile information amongst the group. Once the profile information has been accepted, the profile information will be shared and populated into the requestors address book **202f** and the recipients address book **2041** respectively. According to this embodiment, there isn't a need to manually accept and/or transcribe the data manually into the address book.

According to another exemplary embodiment, a social group encounter may take place in which a requestor **201** and a number of recipients **203** may introduce themselves to each other and desire to exchange profile information, which is typically done by sharing business cards with each other. In this scenario, a single group identification code associated with the social event may be generated, tagged and associated with the particular social event. This scenario works well, for example, in situations where various unfamiliar participants attend a conference, a large meeting, and the like. The multiple attendees, herein, the requestor **201** and the various recipients **203**, may share their profile information **201a**, **203a** with each other. Those in attendance at the event may wish to share their profile information with others at the social event. In operation, attendees at the social event may send their own profile information via the Internet or from a mobile client **202a** resident on their mobile device into the information exchange server **206** via the group identification code. The information exchange server **206** will then compile all of the received profiles, match the requestors **201** with the recipients **203** and share the respected profile information **201a**, **203a**. An acceptance policy may be embedded such that an acceptance message is first sent to the requestor's **201** user interface prompting the requestor **201** to decline or approve the sharing of the profile information with the recipient. Any further modification to a particular profile in the group will be

subsequently updated and revised at the information exchange server **206** and thereafter transmitted to all group member participants associated with that group identification code.

According to another exemplary embodiment of invention, a single group coordinator may be established who controls what profile information may be shared amongst a member's only directory defined group. The member's only directory may be accessed via the Internet or the mobile client **202a**. The member's only directory may display only selected public information to the other members of the group. The individual members can exchange profile information from the member directory. The group can be un-moderated or moderated. An un-moderated group can be set up by one of the participants via the Internet or through the mobile client **202a** by entering a group name and a group identification code associated with the member directory. By sharing this group identification code with others, the other participants can join the member directory group.

A moderated group is one in which a single group coordinator may be established who controls what profile information may be shared amongst the members only directory defined group. The group coordinator maintains management control of the profile information of each of the participants. The group coordinator can choose to selectively share information with each of the participants as a group and/or individually. For example, a university may be given the management control as a group coordinator. Various types of participants may subscribe to the university group, such as for example, alumni, current students, prospective students and faculty. Where an alumni participant may be concerned, all other alumnis may share profile information amongst each other, the group coordinator would solely control the sharing of this information amongst the various alumnis. Where a student is concerned, the group coordinator may selectively share profile information about faculty pertinent to that student's class schedule. Furthermore, where a prospective student may be concerned, the group coordinator may selectively share profile information about admission counselors and/or other information about programs or classes within the university. It is to be noted that the information tagged and shared to selected sub-groups within the university group may include, but is not limited to, personal profiles but may include data information about events, activities, programs, and the like. The group coordinator may also manage the permission of the user or organization to upload existing contact lists. Likewise, the group coordinator may manage member requests.

As part of the management of member requests, the group coordinator can setup "segments" which will allow them to associate members and tag them with words, phrases and/or terms they define. For example, the group coordinator may choose to tag a member to "employee", "partner", "vendor" or "recruiting candidate." This feature is beneficial for marketing purposes. In addition, the group coordinator may customize the registration pages for new users and setup response emails, and/or other alerts when new users attempt to join. The various directories and tags may be tied to various back end systems in accordance with this invention.

It is to be understood that various types of controls and profiles may be created for a particular user. For example, a user may have a first business profile set up with his/her professional information and associated data. Likewise, the user may have a second social profile set up with his/her casual/social information and associated profile information data. Depending upon the environment in which the user is a participant, the user may selectively share one of the particu-

15

lar profiles with a recipient. Likewise, the user may opt-in to make all or portions of his/her personal contact information private to other users who already have their current profile information. Selectable security elements may be tied to various portions of the profile information which may be made visible or invisible to a recipient **203** of the profile information.

In the instance where a group coordinator or organization is managing various pieces of profile information, various privacy controls may be set that would apply to all members in that particular group, such as employees of the organization. The privacy controls can be applied to any profile field, such as in this example to email and phone numbers. Once the profile field is set to private, it cannot be viewed on the user's profile information. The group coordinator may apply privacy controls selectively to various requestors **201** and recipients **203** as it deems fit. Although the profile field for the email and/or phone number may be set to private and is hidden from the recipient **203**, the recipient **203** of the profile information may still be able to email or call the person since the contact information including email address and phone number is still available to the information exchange server **206**. A masked phone number and/or email may be used to communicate between the participants. The ability to communicate, and various other controls tied to the profile information, may be modified as desired. For example, if the requestor **201** decides later to prevent the recipient **203** to communicate with her, then the requestor **201** may select a "disable communication" profile field so that the recipient **203** can no longer call or email her.

According to another aspect of the invention, the information exchange server **206** may capture and include selective membership and financial information in a user's profile information, such as membership, loyalty and credit card account numbers. Examples of such membership and financial information include information typically found on shopping and gym membership cards, shopping loyalty cards, frequent flyer accounts, bank debit and credit cards and the like. The compilation of this profile data information comprises a digital wallet. The advantage of the digital wallet is that the user would no longer have to carry multiple cards in a wallet but would have quick access and use of the information in a secure fashion.

By way of example, when a user wishes to make a financial transaction the user initiates the payment process by selecting the Vendor **382** (FIG. 3A) listed on the mobile device **202** and entering the amount of the transaction. The mobile device **202** transmits the vendor information, the transaction number, the amount of the transaction, and the user information to the information exchange server **206**. The information exchange server **206** then pulls the financial information such as the credit card information of the user from the database **306** and transmits the information to the vendor **382**. The vendor's system would then validate the transaction and send confirmation to the point of sale (POS) terminal at the location where the user is making the mobile payment to complete the transaction. Through use of the present invention, the user's information need not be displayed on their mobile device and all private information can be masked locally on the mobile device **202**. Masking the private information thereby prevents theft from onlookers or anyone that sees, holds, or takes the user's mobile device **202**.

The system of the present invention could also employ a peer to peer transaction by pushing contact information from the mobile device **202** to the POS terminal directly or through the information exchange server **206**. In this embodiment, the POS terminal would receive a request from the mobile device

16

which includes the user's profile. The Vendor **382**, upon receipt of the request, would receive the transaction amount and user's profile information and would then connect to the network **205** to receive the user's financial credit card information. The vendor **382** would then approve the transaction or could transmit an SMS message or email message to the user's mobile device **202** to verify the transaction and amount.

The user may selectively separate and assign the credit cards in the digital wallet depending on whether the nature of the financial transaction to be made is one which is defined as a social or business related transaction. For example, at a business function, if a financial transaction is to be accomplished, the user may conduct a financial transaction with a credit account number related to her business account. Alternatively, the user may desire to make a financial transaction using a non-business related credit account number stored in her digital wallet in a social environment. The exchange of information between the requestors **201** mobile device **202** and the information exchange server **206** containing the digital wallet information may be performed using secured encrypted signaling of information at the time of the transaction throughout the system so as to prevent the sensitive financial information from being illegally accessed. Separate identification codes may be assigned to the various accounts numbers in the digital wallet and securely stored at the information exchange server **206**, as well as in the requestors **201** mobile device **202**.

As mentioned briefly above, identification codes may be associated with various types of membership accounts and rewards programs. The average person carries numerous membership and/or rewards cards on her person. Keeping track of these various membership cards can be cumbersome and monotonous. Thus, according to this invention, it is possible to associate one or many identification codes with each of the user's membership and/or rewards cards. By doing so, the need to carry various membership and/or rewards cards is eliminated.

Retrieval of a particular identification code may be achieved in numerous ways. In one example, the location based system **380** may be employed to automatically determine the location of the mobile device **202** of a user. The location based system **380** may determine the position of a mobile device **202** of a user in a number of commercially available ways, for example, using GPS, XY coordinates as registered by a cell tower, triangulation and/or any other suitable means for determining the location of the mobile device **202** of the user.

For example, FIG. 8K depicts an example user interface **800** that may be prompted as soon as the user enters and/or comes close to the location of the grocery store (i.e. Safeway). As shown, when the information exchange server **206** has acknowledged that a requestors **201** mobile device **202** is within a predetermined proximity of the Safeway, various information such as the offer **832** "50% off groceries this Saturday Jun. 7, 2008 only with this coupon" is sent to the requestor's **201** mobile device **202** and displayed on the user interface **800**. The requestor **201** may select from a variety of buttons **833** to block, reject or send the offer to another contact. Various types of information may be provided from the information exchange server **206** to the user interface **800** of the mobile device **202**. A scanning barcode **830** may also be displayed as shown on the user interface **800** for use upon checkout from the grocery store. The advantage of providing this information accessible by the requestors **201** mobile device **202** is that the requestor **202** will not have to carry a variety of rewards card associated with numerous different

establishments. Other membership and/or rewards programs may be utilized in a similar manner to the one described above, for example, walking into a gym, a requestor **201** may transmit an identification code with her mobile device **202** to the information exchange server **206**, which in turn would transmit the appropriate profile information for that particular member to the Vendor **382** (as seen in FIG. 3A) through the network **205**. The profile information returned from the information exchange server **206** could also be shared directly from peer to peer from the requestors **201** mobile device **202** to a receiving device at the gym, and/or a copy of the returned profile information may be directly sent to the gym establishment with a participating identification code and connected to the network **205**. Likewise, purchases at these various establishments may also be made via the convenience of the requestors **210** mobile device **202** and an associated identification code. The benefit of the systems and methods of this invention is that personal and financial profile information may be securely embedded and masked on the requestor's mobile device **202** yet quickly and conveniently used at the appropriate establishments thereby eliminating the need to physically carry a wallet and/or purse. Leveraging this system, up-to-date contact profile information can be shared with various requesting parties such as, but not limited to, universities, organizations, billing agencies, and the like.

Another aspect of the present invention is to enhance the user's interactivity with their contacts and provide updates/feeds from various different social networks with full interactivity. The present invention enables the requestor **201** or the recipient **203** to set include within their profile all of their social media profile information including the following: LinkedIn, Salesforce, Siebel, Twitter, Dynamics, Facebook, Myspace, Orkut, Plaxo, Bebo, Friendster, FriendFeed, Xanga, Yahoo, SugarCRM, BlackBerryPush, iPhonePush, Geo Location Service, Digg, Vimeo, YouTube, Flickr, loopt, Brightkite, Google LAttitude, Yelp, Delicious, and IMs like Yahoo, AOL, Google Talk, MSA, iChat. Recipients of a profile could then decide manually or set their account to automatically follow or connect to social network accounts of new or updated profiles. For example, if a requestor **201** has a Twitter account identified in their profile the recipient could set their preferences to automatically follow the requestor on Twitter. The system and methods of the present invention can act as a central hub or messaging center for all communications and connections within the social spectrum relating to the participating contact or profile with which a user had connected.

FIG. 4 exemplarily illustrates a flowchart of a process of a recipient **203**, herein referred to as a "public user", installing a mobile client **202a** on a mobile device of the public user based on a request for connection by a requestor **201**. The requestor **201** requests for a connection with the public user using the mobile client **202a** on the requestor's **201** mobile device. The public user may receive **401** the SMS or the email from the requestor **201** on the mobile device through the information exchange server **206** via the internet. If the public user accepts **402** the request for connection by the requestor **201**, the information exchange server **206** captures **403** the connection and replies with a download link for enabling the public user to download the mobile client **202a** on the public user's mobile device. On acceptance of the request to download, the public user becomes a semi private user. The information exchange server **206** then provides minimal information stored in the information database **206a**, required for the establishing the connection. The semi private user first receives the download link from the information exchange server **206** to download the mobile client **202a**. The semi

private user then clicks **404** on the link to initiate a mobile client installer application provided by the information exchange server **206** to download the mobile client **202a**. The information exchange server **206** detects **405** the mobile technology on the semi private user's mobile device and provides an appropriate download of the mobile client **202a**. The mobile client installer application then prompts **406** the semi private user to install the mobile client **202a**.

The mobile client installer application checks **407** if correct runtime of the mobile client **202a** exists while downloading the mobile client **202a**. If the mobile client **202a** does not have the correct runtime, information on minimal requirements for installation and link to download the proper runtime is provided **408** on the semi private user's mobile device. The mobile client installer application then installs the mobile client **202a** on the semi private user's mobile device. The semi private user then accepts **409** connection requests made by the requestor **201** via the information exchange server **206** through the mobile client **202a** installed on the semi private user's mobile device. The semi private user then fills **411** required information fields in the semi private user's registration profile on the mobile client **202a**. On completion of the filling of the information fields by the semi private user in the semi private user's registration profile, the semi private user becomes a private user. The mobile client **202a** then sends **412** the registration profile of the private user to the information exchange server **206**.

FIG. 5 exemplarily illustrates a flowchart of a process of a public user installing a mobile client **202a** on a smartphone. The public user registers **501** on the host website implemented on the information exchange server **206**. The public user then provides a user profile to the information exchange server **206** during the registration. On registration, the public user becomes a private user. The private user then sends **502a** and **502b** a hyperlink from the host website to the private user's smartphone via an email or an SMS to download the mobile client **202a** on the private user's smartphone. On receiving the hyperlink, the private user then selects **503** correct download for the smartphone. The private user is then prompted **504** to install the mobile client **202a**. A mobile client installer application then checks **505** if correct runtime of the mobile client **202a** exists while downloading the mobile client **202a**. If the mobile client **202a** does not have the correct runtime, information on minimal requirements for installation and link to download the proper runtime is provided on the private user's smartphone. The mobile client installer application then installs the mobile client **202a** on the private user's smartphone. The private user then accepts **506** multiple security and connection requests from the information exchange server **206** through the mobile client **202a** installed on the private user's smartphone. The private user then retrieves **507** the private user's user profile from the information exchange server **206** using the mobile client **202a** on the private user's smartphone.

FIG. 6 exemplarily illustrates a flowchart of a process of a public user installing a mobile client **202a** on a smartphone by accessing a host website from the public user's smartphone. The public user navigates **601** to a download mobile client screen from a host website using a web browser on the public user's smartphone. The public user then selects **602** correct download for the smartphone. The public user is then prompted **603** to install the mobile client **202a**. A mobile client installer application then checks **604** if correct runtime of the mobile client **202a** exists while downloading the mobile client **202a**. If the mobile client **202a** does not have the correct runtime, information on minimal requirements for installation and link to download the proper runtime is pro-

vided on the public user's smartphone. The mobile client installer application then installs the mobile client **202a** on the public user's smartphone. The public user then accepts **605** multiple security and connection requests from the information exchange server **206** through the mobile client **202a** installed on the public user's smartphone. The public user then fills **606** required information fields in the public user's registration profile using the mobile client **202a**. The mobile client **202a** on the public user's smartphone then sends **607** the registration profile to the information exchange server **206**.

FIG. 7 exemplarily illustrates a flowchart of a process of providing a mobile client **202a** to a public user. The public user receives **701a** and **701b** an email or an SMS with a download link from the information exchange server **206**. The public user then clicks **702** on the download link. The public user then selects **703** correct download for the smartphone. The public user is then prompted **704** to install the mobile client **202a**. A mobile client installer application then checks **705** if correct runtime of the mobile client **202a** exists while downloading the mobile client **202a**. If the mobile client **202a** does not have the correct runtime, information on minimal requirements for installation and link to download the proper runtime is provided on the public user's smartphone. The mobile client installer application then installs the mobile client **202a** on the public user's smartphone. The public user then accepts **706** security and connection requests from the information exchange server **206** through the mobile client **202a** installed on the private user's smartphone. The public user then fills **707** required information fields in the public user's registration profile using the mobile client **202a**. The mobile client **202a** on the public user's smartphone then sends **708** the registration profile to the information exchange server **206**. On sending the registration profile, the public user becomes a private user. The information exchange server **206** then sends connection request to the private user's smartphone for establishing connection between the private user and other private users. If the private user accepts **709** the connection request, then the mobile client **202a** sends **710** the acceptance to the information exchange server **206**. If the private user declines **709** the connection request, then the mobile client **202a** sends **711** the denial to the information exchange server **206**.

FIG. 9 is a block diagram illustrating the basic components of an example mobile device **900** which may be employed with systems and methods of this invention. As shown, the mobile device **900** includes a display **901**, a processor **902**, a user interface module **904**, a communications module **906**, and memory **908**, including ROM **910** and RAM **912**.

The processor **902** may include any hardware and/or software necessary for operating and/or controlling the user interface **904**, the wireless communications module **906**, and the memory **908**. For example, the processor **902** may be individual digital logic components, a processor, a microprocessor, an application-specific integrated circuit (ASIC), and the like. The processor **902** may have its own memory such as random access memory (RAM), register memory, cache memory, and the like.

The processor **902** may be in communication with and/or in control of the user interface **904**, the wireless communications module **906**, and/or the memory **908**. For example, the processor **902** may direct the user interface **904** to receive input from the user or present content on display **901**, transmit or receive data via the wireless communications module **906**, or retrieve preferences from a user profile stored in the memory **908**.

The processor **902** may operate on computer-executable instructions. Computer-executable instructions may include computer-readable instructions, for example machine code, byte code, script language, runtime code, and the like. The computer-executable instructions for example, when executed by the processor **902**, may cause the processing component to perform the methods described in FIGS. 1 and 4-7.

The user interface **904** may be, in any combination of hardware and/or software, any component, system and/or subsystem for receiving input from a user and/or outputting information to the user. The user interface **904** may include display **901**, a number pad, or a keyboard. For example, the user interface **904** may include a telephone keypad, programmable softkeys, mechanical buttons, touch screens, and the like. One or more display screens **901** may provide visual output, for example the display of content pertinent to systems and methods of this invention. The user interface **904** may include a speaker for audio output and/or a microphone for audio input.

The wireless communications module **906** may be, in any combination of hardware and/or software, any component, system, and/or subsystem for providing wireless communications to or from the mobile device. The wireless communications module **906** may provide a wireless communications channel between wireless devices. The wireless communications module **906** may provide point-to-point wireless communications between mobile device **900** and a peer device. For example, the wireless communications module **906** may communicate in accordance various commercially available BLUETOOTH® protocols, and the like.

Wireless communications module **906** may provide radio frequency (RF) communications between mobile device **900** and other fixed and wireless devices, for example computing device **302**, mobile device **303**, smart phones **304**, as well as other cell phones, laptops, PDAs, and other commercially available communications devices. Wireless communications module **906** may provide a wireless communications channel between mobile device **900** and a wireless communications network. Wireless communications module **906** may provide cellular communications or wireless data network communications, for example Wi-Fi (IEEE 802.11), WiMAX (IEEE 802.16), and the like.

Memory **908** may be any component, system, and/or subsystem suitable for storing data. For example, memory **908** may include storage media in the form of volatile and/or nonvolatile memory such as read only memory (ROM) **910** and random access memory (RAM) **912**. A basic input/output system (BIOS), containing basic routines that help to transfer information between components within mobile device **900**, such as during start-up, is typically stored in ROM **910**. RAM **912** typically contains data and/or application modules that are immediately accessible to and/or presently being operated on by processor **902**.

Mobile device **900** may also include other removable/non-removable, volatile/nonvolatile storage media that can be used as part of memory **908**, for example hard disk drives, optical disc drives, flash memory cards, and the like. The storage media discussed above provide for storage of computer-readable instructions, data structures, program modules and other data for the mobile device **900**, which may be executed on processor **902**.

A GPS module **907** may be integrated as the location based service **380** in accordance with the present invention. Together with various satellites **914**, the GPS module **907** is capable of determining the current location of the mobile device **900**. Three GPS satellites **914**, of the total of twenty-

four GPS satellites **914** that circumnavigate the globe, are shown to transmit power radio signals at a predetermined frequency in the UHF band. The GPS signal contains three different pieces of information, i.e., a pseudo-random code, ephemeris data, and almanac data. The pseudo-random code identifies the transmitting satellite **914**; the ephemeris data tells a GPS receiver where the GPS satellite **914** should be at any time throughout the day; and the almanac data, which is constantly transmitted by each satellite **914**, contains important information about the status of the satellite, i.e., healthy or unhealthy, and current date and time.

A GPS receiver within the GPS module **907** uses an internal antenna to capture GPS signals sent by the three GPS satellites **914**. The GPS module **907** calculates pseudo ranges from the satellites **914** to its own position within the mobile device **900**. By receiving the GPS signals from the GPS satellites **914**, the GPS module **907** is able to compare the time each received signal was transmitted by the satellites **914** with the time the signal was received. The GPS module **914** may use this comparison information to calculate degrees longitude and latitude and to triangulate the position of the mobile device **900**. Although not shown in FIG. 9, the mobile device **900** also contains an antenna for transmitting and receiving wireless communications. The location of the mobile device **900** could also be determined through use of cell tower triangulation through receipt and transmission of wireless signals from one or more cell towers, transmitters, and/or wireless devices.

It will be readily apparent that the various methods and algorithms described herein may be implemented in a computer readable medium appropriately programmed for general purpose computers and computing devices. Typically a processor, for e.g., one or more microprocessors will receive instructions from a memory or like device, and execute those instructions, thereby performing one or more processes defined by those instructions. Further, programs that implement such methods and algorithms may be stored and transmitted using a variety of media, for e.g., computer readable media in a number of manners. In one embodiment, hardwired circuitry or custom hardware may be used in place of, or in combination with, software instructions for implementation of the processes of various embodiments. Thus, embodiments are not limited to any specific combination of hardware and software. A 'processor' means any one or more microprocessors, Central Processing Unit (CPU) devices, computing devices, microcontrollers, digital signal processors or like devices. The term 'computer-readable medium' refers to any medium that participates in providing data, for example instructions that may be read by a computer, a processor or a like device. Such a medium may take many forms, including but not limited to, non-volatile media, volatile media, and transmission media. Non-volatile media include, for example, optical or magnetic disks and other persistent memory volatile media include Dynamic Random Access Memory (DRAM), which typically constitutes the main memory. Transmission media include coaxial cables, copper wire and fiber optics, including the wires that comprise a system bus coupled to the processor. Transmission media may include or convey acoustic waves, light waves and electromagnetic emissions, such as those generated during Radio Frequency (RF) and Infrared (IR) data communications. Common forms of computer-readable media include, for example, a floppy disk, a flexible disk, hard disk, magnetic tape, any other magnetic medium, a Compact Disc-Read Only Memory (CD-ROM), Digital Versatile Disc (DVD), any other optical medium, punch cards, paper tape, any other physical medium with patterns of holes, a Random Access

Memory (RAM), a Programmable Read Only Memory (PROM), an Erasable Programmable Read Only Memory (EPROM), an Electrically Erasable Programmable Read Only Memory (EEPROM), a flash memory, any other memory chip or cartridge, a carrier wave as described hereinafter, or any other medium from which a computer can read. In general, the computer-readable programs may be implemented in any programming language. Some examples of languages that can be used include C, C++, C#, .NET or JAVA. The software programs may be stored on or in one or more mediums as an object code. A computer program product comprising computer executable instructions embodied in a computer-readable medium comprises computer parsable codes for the implementation of the processes of various embodiments.

The mobile devices of the requestor **201** and the recipient **203** may support Java of Sun Microsystems Inc., more specifically Java 2 Micro Edition (J2ME™), Windows Mobile .Net Compact Framework of Microsoft Inc., Palm, Symbian™, Linux framework. Exemplarily, the mobile client **202a** may be implemented on the J2ME platform. These environments provide functionalities in the libraries to create the user interface of the mobile client **202a** and perform all the required functions of the method and system disclosed herein. Other advantages of these frameworks are portability across mobile devices that run on different operating systems. The mobile client **202a** may be rendered independent of the operating system of the mobile device. Some of the mobile phones equipped with both wireless network and telephony data capabilities may use either of the two to communicate with the information exchange server **206**. The transport protocol that is used between the mobile client **202a** and the information exchange server **206** may be hypertext transfer protocol (HTTP), Secure Sockets Layer (SSL), or extensible markup language-remote procedure calls (XML-RPC).

Where databases are described such as the information database **206a**, it will be understood by one of ordinary skill in the art that (i) alternative database structures to those described may be readily employed, and (ii) other memory structures besides databases may be readily employed. Any illustrations or descriptions of any sample databases presented herein are illustrative arrangements for stored representations of information. Any number of other arrangements may be employed besides those suggested by, e.g., tables illustrated in drawings or elsewhere. Similarly, any illustrated entries of the databases represent exemplary information only; one of ordinary skill in the art will understand that the number and content of the entries can be different from those described herein. Further, despite any depiction of the databases as tables, other formats including relational databases, object-based models and/or distributed databases could be used to store and manipulate the data types described herein. Likewise, object methods or behaviors of a database can be used to implement various processes, such as the described herein. In addition, the databases may, in a known manner, be stored locally or remotely from a device that accesses data in such a database.

The present invention can be configured to work in a network environment including a computer that is in communication, via a communications network, with one or more devices. The computer may communicate with the devices directly or indirectly, via a wired or wireless medium such as the Internet, Local Area Network (LAN), Wide Area Network (WAN) or Ethernet, Token Ring, or via any appropriate communications means or combination of communications means. Each of the devices may comprise computers, such as those based on the Intel® processors, AMD® processors,

UltraSPARC® processors, etc. that are adapted to communicate with the computer. Any number and type of machines may be in communication with the computer.

The foregoing examples have been provided merely for the purpose of explanation and are in no way to be construed as limiting of the present method and system disclosed herein. While the invention has been described with reference to various embodiments, it is understood that the words, which have been used herein, are words of description and illustration, rather than words of limitation. Further, although the invention has been described herein with reference to particular means, materials and embodiments, the invention is not intended to be limited to the particulars disclosed herein; rather, the invention extends to all functionally equivalent structures, methods and uses, such as are within the scope of the appended claims. Those skilled in the art, having the benefit of the teachings of this specification, may affect numerous modifications thereto and changes may be made without departing from the scope and spirit of the invention in its aspects.

What is claimed is:

1. A method of managing mobile exchange of profile information between a requestor mobile device and at least one recipient mobile device, comprising the steps of:

- providing a mobile client on the requestor mobile device;
- providing a requestor profile to an information exchange server by the requestor mobile device using the mobile client;
- generating and transmitting an identification code to the information exchange server that initiates a request to share the requestor profile between the requestor mobile device and the at least one recipient mobile device using the mobile client;
- requesting the mobile client on the at least one recipient mobile device to accept the request to share the requestor profile from the requestor mobile device;
- providing a recipient profile to the information exchange server by the at least one recipient mobile device using the mobile client;
- storing the requestor profile and recipient profile in an information database associated with the information exchange server, wherein the information database stores a log of calls, electronic mails, and text messages sent from a mobile device using the mobile client;
- transferring the recipient profile from the information exchange server to the mobile client on the requestor mobile device on acceptance of the request by the at least one recipient mobile device, and wherein the requestor profile is transferred from the information exchange server to the at least one recipient mobile device; and
- automatically updating the transferred recipient profile on the requestor mobile device and the transferred requestor profile on the at least one recipient mobile device in response to changes made to the recipient profile and the requestor profile.

2. The method of claim 1, wherein the requestor mobile device and the at least one recipient mobile device forms a plurality of mobile devices, all being commonly associated with an event, so that when one or more of the plurality of mobile devices, transmits an identification code which includes an event identifier to the information exchange server, all of the plurality of mobile devices which transmit an identification code which includes the event identifier will receive the profile information associated with the plurality of mobile devices which transmit an identification code which includes the event identifier.

3. The method of claim 1, wherein the at least one recipient mobile device is a plurality of mobile devices, all being commonly associated with a group code as members of a group, and wherein the profile information of the members of the group is supervised by a centralized profile manager.

4. The method of claim 3, wherein the centralized profile manager selectively receives profile information from the requestor mobile device and the recipient mobile devices, and wherein the centralized profile manager selectively shares profile information about the members of the group to the members of the group.

5. The method of claim 1, further comprising a step of providing an electronic business card bowl application to a business organization with a business profile provided on the information exchange server for collecting profile information provided by customers using the mobile client via the information exchange server.

6. A system for managing mobile exchange of profile information between a requestor mobile device and a recipient mobile device, comprising:

- a mobile client provided on the requestor mobile device and the recipient mobile device, comprising:

- an information input software module that enables the requestor mobile device and the recipient mobile device to provide a requestor profile and a recipient profile respectively to an information exchange server;

- a request software module which transmits an identification code to the information exchange server to request an exchange of the requester profile and the recipient profile information between the requestor mobile device and the recipient mobile device;

- an information update software module that automatically updates the recipient profile and the requestor profile on the requestor mobile device and the recipient mobile device respectively based on changes made to the recipient profile and the requestor profile;

- the information exchange server comprising:

- an information database for storing the requestor profile and the recipient profile provided by the requestor mobile device and the recipient mobile device respectively through the mobile client, wherein the information database stores a log of calls, electronic mails, and text messages sent from a mobile device using the mobile client; and

- an information transfer software module for transferring the recipient profile to the mobile client on the requestor mobile device on acceptance of the request by the recipient mobile device, wherein the information transfer software module transfers the requestor profile to the mobile client on the recipient mobile device.

7. The system of claim 6, wherein the identification code includes an identifier associated with at least one profile or an event.

8. The system of claim 7, wherein the identifier associated with at least one profile or an event is embodied in a short code SMS, an MMS, or a USSD message.

9. The system of claim 6 wherein the profile information is selectively modifiable and comprises at least one of: masked and unmasked contact information, location based information, meeting identity, meeting time, contextual information, billing information or notes.

10. The system of claim 6, further comprises a location based service that determines the position of the requestor mobile device and the position of the recipient mobile device, such that when the requestor mobile device and the recipient

25

mobile device have both elected to share profile information with each other at approximately the same time, and are within a predetermined distance of each other, the information exchange server may automatically initiate an invite message to the requester mobile device and the recipient mobile device for acceptance to exchange profile information.

11. The system of claim 6, wherein the information database is adapted to receive, store and communicate profile information about membership and rewards information, such that as desired, the requestor mobile device may initiate retrieval of the stored profile information related to the membership and rewards information that is stored in the information exchange server.

12. The system of claim 6, further comprising an electronic business card bowl application for collecting profile information provided by customers using the mobile client via the information exchange server.

13. The system of claim 6, wherein the mobile client further comprises an offer bin software module for receiving advertisements from advertisers on a mobile device using the mobile client.

14. A system for managing mobile exchange of profile information between a requestor mobile device and a recipient mobile device, comprising:

a mobile client provided on both, the requestor mobile device and the recipient mobile device, comprising:

an information input software module that enables the requestor mobile device and the recipient mobile device to provide a requestor profile and a recipient profile respectively to an information exchange server;

a request software module that requests an exchange of profile information initiated when an identification code, associated with at least one profile or an event, is transmitted by at least one of the requestor mobile device and the recipient mobile device to the information exchange server;

an information update software module that automatically updates the recipient profile and the requestor profile transferred from the information exchange server on the requestor mobile device and the recipient mobile device respectively based on changes made to the recipient profile and the requestor profile;

the information exchange server comprising:

an information database for storing the requestor profile and the recipient profile provided by the requestor mobile device and the recipient mobile device respectively through the mobile client,

wherein the information database stores a log of calls, electronic mails, and text messages sent from a mobile device using the mobile client; and

an information transfer software module for transferring the recipient profile to the mobile client on the requestor mobile device on acceptance of the request by the recipient mobile device, wherein the information transfer software module transfers the requestor profile to the mobile client on the recipient mobile device.

15. The system of claim 14, wherein the identification includes an identifier associated with at least one profile or an event.

16. The system of claim 14, further comprises a location based service that determines the position of the requestor mobile device and the position of the recipient mobile device, such that when the requestor mobile device and the recipient

26

mobile device have both elected to share profile information with each other at approximately the same time, and are within a predetermined distance of each other, the information exchange server may automatically initiate an invite message to the requestor mobile device and the recipient mobile device for acceptance to exchange profile information.

17. A method of managing mobile exchange of profile information between a requestor mobile device and at least one recipient mobile device, comprising the steps of:

providing a mobile client on the requestor mobile device; providing a requestor profile to an information exchange server by the requestor mobile device using the mobile client;

generating and transmitting an identification code to the information exchange server that initiates a request to share the requestor profile between the requestor mobile device and the at least one recipient mobile device using the mobile client;

requesting the mobile client on the at least one recipient mobile device to accept the request to share the requestor profile from the requestor mobile device;

storing the requestor profile and recipient profile in an information database associated with the information exchange server,

wherein the information database stores a log of calls, electronic mails, and text messages sent from a mobile device using the mobile client;

transferring the requestor profile from the information exchange server to the at least one recipient mobile device on acceptance of the request; and

automatically updating the transferred requestor profile on the recipient mobile device in response to changes made to the requestor profile.

18. A system for managing mobile exchange of profile information between a requestor mobile device and a recipient mobile device, comprising:

a mobile client provided on the requestor mobile device and the recipient mobile device, comprising:

an information input software module that enables the requestor mobile device to provide a requestor profile to an information exchange server;

a request software module which transmits an identification code to the information exchange server to request an share the requestor profile with the recipient mobile device;

an information update software module that automatically updates the requestor profile on the recipient mobile device based on changes made to the requestor profile;

the information exchange server comprising:

an information database for storing the requestor profile provided by the requestor mobile device through the mobile client,

wherein the information database stores a log of calls, electronic mails, and text messages sent from a mobile device using the mobile client; and

an information transfer software module for transferring the requestor profile to the mobile client on the recipient mobile device on acceptance of the request.

19. The system of claim 18, wherein the requestor profile includes financial information which can be used by the requestor to process payments using the requestor mobile device.